



DANIEL
DEFENSE®
» FREEDOM. PASSION. PRECISION.®

2023 CATALOG

A person wearing camouflage clothing is holding a rifle in a forest setting. The rifle has a gold-colored upper receiver and a black lower receiver. The person is also wearing a watch and a cap. The background is a blurred forest with brown leaves on the ground.

DB[®]









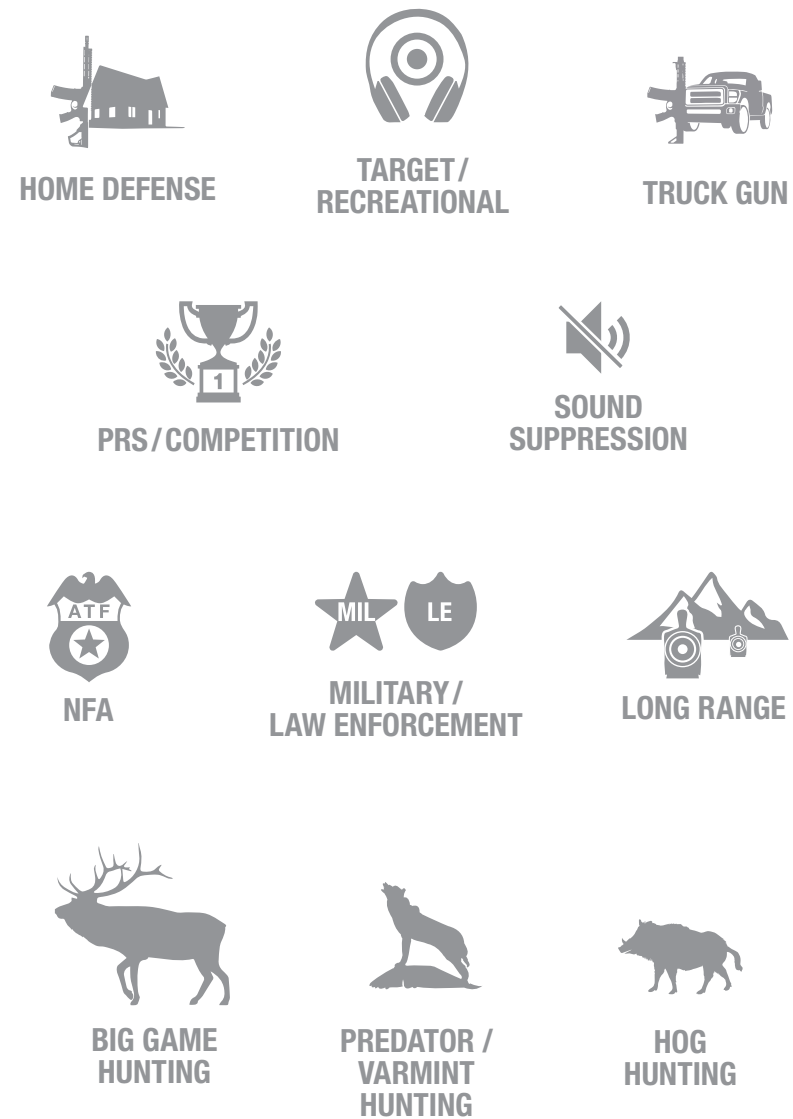

»[®] FREEDOM. PASSION. PRECISION.[®]

-  BLACK
-  MIL SPEC +.
-  DANIEL DEFENSE
TORNADO.
-  DANIEL DEFENSE.
DEEP WOODS.
-  FDE
-  COBALT
-  GUN METAL GRAY
-  COYOTE TAN
-  OLIVE DRAB
-  KRYPTEK HIGHLANDER.
-  RATTLECAN.

USAGE/APPLICATION ICONS

Each Daniel Defense firearm is designed to be versatile and customizable for specific or multiple applications. Visit danieldefense.com/usage for complete usage recommendations.



- 
HOME DEFENSE
- 
TARGET/
RECREATIONAL
- 
TRUCK GUN
- 
PRS / COMPETITION
- 
SOUND
SUPPRESSION
- 
NFA
- 
MILITARY /
LAW ENFORCEMENT
- 
LONG RANGE
- 
BIG GAME
HUNTING
- 
PREDATOR /
VARMINT
HUNTING
- 
HOG
HUNTING



FIREARMS OVERVIEW	04
DD4™ RIII™ RIFLES	06
DDM4® RIFLES	10
DD5® RIFLES	18
HUNTER SERIES RIFLES	22
DELTA 5® BOLT-ACTION RIFLES	26
SOUND SUPPRESSORS	34
UPPER RECEIVERS	36
RAIL SYSTEMS	40
HAMMER FORGED BARRELS	48
PARTS / ACCESSORIES	52
SPECIFICATION CHARTS	60
APPAREL / GEAR	66





DDM4

DDM4.PDW

300BLK
7.0" M



DDM4.V1.

5.56
16" M



DDM4.V4.s

5.56
11.5" M



DDM4.V7.s

5.56
11.5" M



DDM4.V7.

5.56
16" M



DDM4.V7.slw

5.56
14.5" M



DDM4.V7. PRO

5.56
18" M



DDM4.V9.

5.56
16" M



DDM4ISR.

300BLK
9" M



DDM4.300.s

300BLK
10.3" M



M4A1

5.56
14.5" M



MK12

5.56
18" M



MK18

5.56
10.3" M



RIII

DD4.RIII.s

5.56
11.5" M



DD4.RIII.

5.56
16" M



M4A1 RIII.

5.56
14.5" M



MK18 RIII.

5.56
10.3" M



DD5

DD5.SBR

7.62
12.5" M



DD5.V3

7.62
16" M



DD5.V4

7.62 6.5 CM
18" M



DD5.V5

.260REM 6.5 CM
20" M



HUNTER SERIES

DDM4.HUNTER

300BLK
16" M



DDM4.HUNTER

5.56
18" M



DDM4.HUNTER

6.8SPC
18" M



DD5.V4.HUNTER

.260 6.5 CM
18" M



DD5.V5.HUNTER

.260 6.5 CM
20" M



DELTA

DELTA 5.

.308
20" M



DELTA 5.

6.5 CM
24" M



DELTA 5. PRO VARMINT

.308
16" M



DELTA 5. PRO VARMINT

6.5 CM
18" M



DELTA 5. PRO HPALMA

.308
20" M



DELTA 5. PRO HPALMA

6.5 CM
24" M



DELTA 5. PRO VARMINT

6.5 CM 6 MM
26" M





MORE CONTROL. MORE FLEXIBILITY. LESS WEIGHT.

BRINGING OUR SOCOM II LEGACY INTO THE FUTURE

To create our R111 family of rifles, we took the tried-and-true features that set our AR-15-style rifles apart from the competition and added two next-level enhancements: (1) a fully ambidextrous lower and (2) our new RIS III rail system. An ambidextrous bolt catch, magazine release, and safety selector provide right- and left-handed shooters with even greater flexibility and control, so they can operate these mechanisms without having to move or remove their dominant hand from the rifle's grip. Our RIS III rails—modeled after the revolutionary RISII two-piece handguard developed for SOCOM—feature M-LOK attachment for reliability and reduced weight. The result is a family of lightweight, ambidextrous, smaller-caliber rifles unlike anything we've offered before.

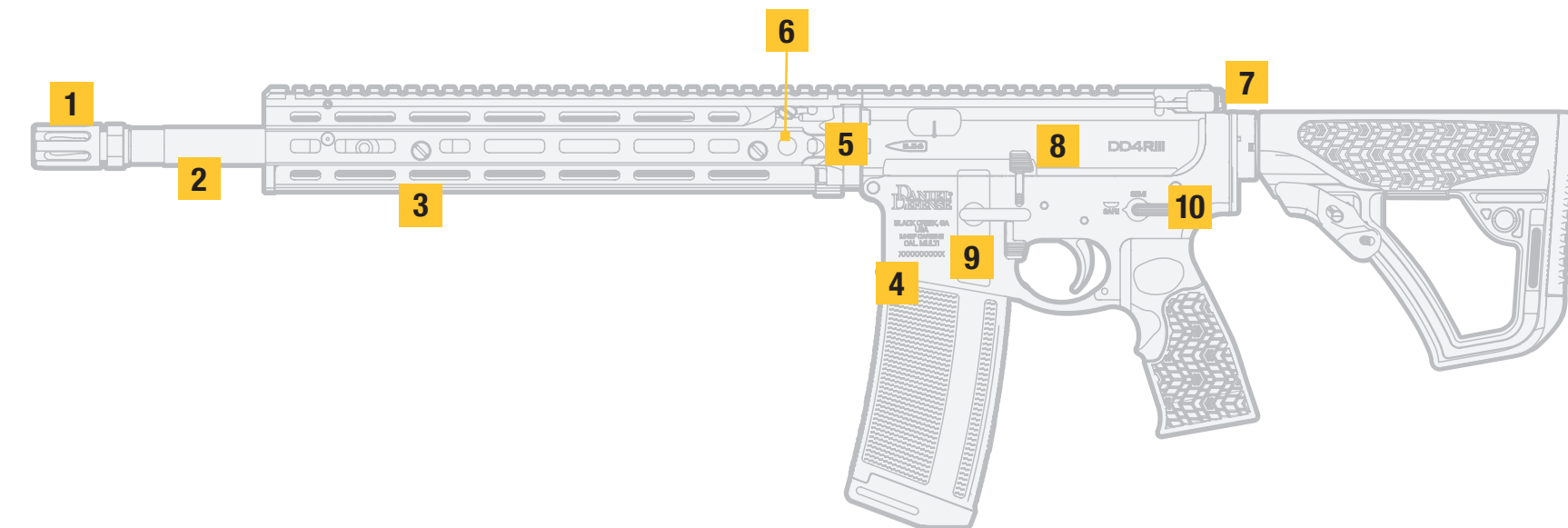

1 MUZZLE DEVICE

Manufactured from high-strength, corrosion-resistant 17-4 PH stainless steel, Daniel Defense Flash Suppressors are designed to eliminate flash associated with muzzle blast



2 COLD HAMMER FORGED

Intense hydraulic pressure process that forms the most accurate and longest-lasting barrels attainable



3 DETACHABLE LOWER RAIL

Lower section is removable without affecting structural integrity or interfering with barrel harmonics



4 FLARED MAGWELL

Our widened and beveled magwell funnels magazines into place for the fastest, most secure reloads possible

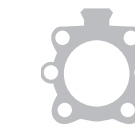

5 6-BOLT BOLT-UP SYSTEM

Patented Bolt-Up System's 6-bolt design is battle tested and allows the rail system to free float the barrel, which will ensure barrel harmonics are not affected during operation



6 QD POINTS

Integral QD Points on each side near the receiver are flush and eliminate the need to install an aftermarket QD mount



7 GRIP-N-RIP® CHARGING HANDLE

Independently ambi charging handle with anti-gas features for a better shooting experience

FULLY AMBI CONTROLS



8 AMBI BOLT CATCH

Accessible on both sides of the receiver, gives right-handed shooters the ability to lock and release the bolt without having to remove their hand from the grip



9 AMBI MAG RELEASE

Mag Release is accessible on both sides of the receiver so the shooter does not have to break their shooting grip to reach the release



10 AMBI SAFETY SELECTOR

For right- or left-handed shooters



DD4 R111



A lighter weight, fully ambidextrous version of our industry-standard DDM4 that offers right- and left-handed shooters more flexibility and control. A no-brainer choice for anyone looking for a reliable, durable rifle perfect for shooting sports as well as tactical and defensive applications.

Fully ambidextrous lower enables shooter to operate important rifle mechanisms without moving dominant hand from rifle grip

16" Government-profile barrel and mid-length gas system for smoother recoil impulse

12.5" RIS III Rail features M-LOK attachment for reliability and reduced weight



M4A1 R111



How do you make our proven M4A1 design even more user friendly? We did so by adding a fully ambidextrous lower to provide right- and left-handed shooters with even more flexibility and control. We also replaced the RIS II Rail System with our new RIS III, which reduces weight by using M-LOK attachment instead of picatinny.

Fully ambidextrous lower enables shooter to operate important rifle mechanisms without moving dominant hand from rifle grip

14.5" chrome-lined, heavy-phosphate-coated M4-profile barrel features a pinned & welded DD Flash Suppressor to extend length to NFA-required 16"

12.5" RIS III Rail features M-LOK attachment for reliability and reduced weight



DD4 R111s



We took a configuration favored by law enforcement professionals and agencies and added our RIS III rail with M-LOK attachment for even lighter weight. This reliable short-barreled rifle is fully ambidextrous for even more control and maneuverability. It's small but packs a wallop using a wide range of ammunition.

Fully ambidextrous lower enables shooter to operate important rifle mechanisms without moving dominant hand from rifle grip

10.5" RIS III Rail features M-LOK attachment for reliability and reduced weight

11.5" free-floating Government-profile barrel & carbine gas system for maneuverability



MK18 R111



DESIGNED FOR PROS, REFINED FOR YOU with two enhancements for more flexibility and control. We took our maneuverable MK18 and added a fully ambidextrous lower to allow right- and left-handed shooters to operate important mechanisms without moving or removing their hand from the grip. Plus, our RIS III rail cuts down on weight by using M-LOK attachment.

Fully ambidextrous lower enables shooter to operate important rifle mechanisms without moving dominant hand from rifle grip

10.3" chrome-lined, heavy-phosphate-coated Government-profile barrel provides outstanding maneuverability & durability

9.5" RIS III Rail features M-LOK attachment for reliability and reduced weight



SEE FIREARMS LINEUP:
DANIELDEFENSE.COM/RIFLES



OUR STANDARD AR15— THE INDUSTRY'S GOLD STANDARD

DANIEL DEFENSE® 5.56 MM / .300 BLACKOUT FIREARMS

Only the very best will do. Our DDM4 rifles are made with the finest materials, precision engineering, and an unwavering commitment to quality and excellence. What's more, they're used on the job by the very best, including many professionals whose very lives depend on their firearms performing flawlessly. Every. Single. Time. If these mission-proven firearms can help these hardcore users protect our freedoms, count on them to help protect the people and things you love.



DDM4V1.  Black



The rifle that started it all and set the benchmark in the industry. Designed and engineered to meet, and exceed, the needs of hardcore tactical professionals and shooting enthusiasts—anyone who appreciates quality, durability, and outstanding performance.

16" M4-profile chrome-lined barrel with heavy phosphate coating & Daniel Defense Forged Front Sight Base

DDM4 Rail 12.0 FSP allows for light or aiming device mounted forward of Daniel Defense Forged Front Sight Base for optimal ergonomics

A1.5 Fixed Rear Sight with Patented Rock & Lock technology is engineered to not impede use of the charging handle



DDM4V4s  Black



A lightweight and dependable SBR (short-barreled rifle) designed around a configuration we've provided law enforcement personnel and agencies for years. Reliable, maneuverable, and accurate, this small but mighty firearm delivers optimal ballistics using a wide range of ammo.

11.5" free-floating Government-profile barrel & Carbine length gas system for maneuverability

Fully integrated QD Swivel Attachment Points for tangle-free ambidextrous sling attachment

DDM4 Rail 10.0 shields the barrel and low-profile gas block while providing ample room for accessories

This firearm is a regulated item by the National Firearms Act (NFA). Please check with your local and state municipalities for any further regulatory requirements. It is the buyer's responsibility to make sure they comply with all NFA rules and applicable laws.



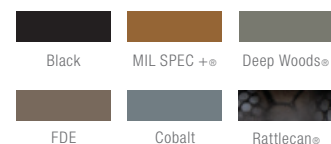

DDM4 V7



The lightweight, modular DDM4 V7 is a welcome addition to any gun safe. Its 15.0" MFR rail features popular M-LOK attachment, and a Mid-length gas system provides smooth, reliable cycling while also reducing perceived recoil and wear and tear on parts. Plan on putting shots on target for many years with this workhorse rifle.

15" rail with M-LOK attachment technology provides weight savings and plenty of space for accessories

Daniel Defense improved Flash Suppressor significantly reduces flash signature

16" chrome-lined, heavy-phosphate-coated Government-profile barrel for accuracy & durability



DDM4 V7 SLW



One of the lightest, fastest-handling rifles available in the DDM4 line-up, tipping the scales at under 6 lbs. Built around a Cold Hammer Forged, 14.5" Lightweight profile barrel, the V7 SLW has an Extended Flash Suppressor which is pinned and welded to reach the NFA required 16" minimum barrel length.

13.5" rail with M-LOK attachment technology provides weight savings and plenty of space for accessories

Daniel Defense improved Flash Suppressor significantly reduces flash signature

Lightweight, 14.5" chrome-lined, heavy-phosphate-coated Mid-length barrel, HP/MPI tested



DDM4 V7 S



This short-barreled version of our DDM4 V7 features an 11.5" Government-profile barrel for maximum maneuverability and a Carbine length gas system for smooth, reliable cycling. M-LOK attachment technology with a Daniel Defense MFR 10.0 rail provides plenty of real estate for accessories without weighing this quick, fast-shooting weapon down.

11.5" free-floating Government-profile barrel & Carbine length gas system for maneuverability

Daniel Defense improved Flash Suppressor significantly reduces flash signature

MFR 10.0 rail with M-LOK attachment technology provides weight savings and plenty of space for accessories



Geissele® Automatics Super Dynamic 3 Gun Trigger for shorter split times

DDM4 V7 PRO



Designed and built with the needs of multi-gun competitors in mind. With outstanding ergonomics, superior cooling, and plenty of space for optics, look for shorter split times, more precise follow-up shots, and reduced fatigue to help you dominate your next shooting competition.

Daniel Defense Buttstock & Pistol Grip improve comfort and control

Daniel Defense Muzzle Climb Mitigator reduces recoil and muzzle rise, keeping you on target for quicker follow-up shots

18" S2W barrel & Rifle length gas system for accuracy and reduced recoil

This firearm is a regulated item by the National Firearms Act (NFA). Please check with your local and state municipalities for any further regulatory requirements. It is the buyer's responsibility to make sure they comply with all NFA rules and applicable laws.





DDM4 V9



Black



An extended quad rail provides the option of extending the support hand closer to the muzzle to drive the gun more precisely and prevent over-travel when transitioning between multiple targets. Great for tactical applications, competition—or both.

15" DDM4 Rail provides ample space for optics & accessories while allowing for max sight radius for accurate shooting with mounted iron sights

16" chrome-lined, heavy-phosphate-coated Government-profile barrel for accuracy & durability

Mid-length gas system delivers smoother recoil impulse, allowing for quick but precise follow-up shots



DDM4 300S



Black



A high-performance, short-barreled rifle chambered in the versatile .300 Blackout to deliver projectiles with greater muzzle energy and better penetration than the 5.56mm cartridge. An outstanding choice for home defense, target shooting, suppressed operation, and tactical applications.

10.3" chrome-lined, heavy-phosphate-coated S2W-profile barrel provides extreme maneuverability

Adjustable Daniel Defense Buttstock and DD Pistol Grip add to the weapon's ergonomics and fast handling

Uses a standard 5.56 bolt to deliver hard-hitting .30 caliber projectiles

This firearm is a regulated item by the National Firearms Act (NFA). Please check with your local and state municipalities for any further regulatory requirements. It is the buyer's responsibility to make sure they comply with all NFA rules and applicable laws.



DDM4 PDW



Black

FDE

Cobalt



The ultra-compact DDM4 PDW was made for protecting your family or anything else that's important to you. It comes in .300 BLK with a 7" barrel. With an overall length of only 20.75", it's easy to transport or keep stowed in your car or truck for emergencies. Built to our legendary Daniel Defense quality standards, this short-barreled rifle is reliable, quiet, fun to shoot, and a great addition to any gun collection. Or the perfect first piece for starting one. Protect what's yours—and your right to bear arms—with this one-of-a-kind firearm.

Ultra-compact platform with 7", 1:7" twist barrel for compatibility with subsonic and supersonic loads

CQB Gen 7 Stock with enhanced buffer system functions reliably suppressed or unsuppressed

Linear compensator directs muzzle blast forward of the shooter; muzzle threads (5/8-24) allow for muzzle device customization



**INTEGRATED SUPPRESSOR
WITH REMOVABLE BAFFLE**

User-serviceable monocoire baffle can be easily removed for periodic cleaning to maintain peak performance.

DDM4ISR



A suppressor is literally part of the barrel on this high-performance, versatile weapon, so there's never any re-zeroing for suppressed versus unsuppressed fire. Optimized for the .300 Blackout cartridge, this rifle places both subsonic and supersonic projectiles on target with precision and unwavering reliability.

This firearm is a regulated item by the National Firearms Act (NFA). Please check with your local and state municipalities for any further regulatory requirements. It is the buyer's responsibility to make sure they comply with all NFA rules and applicable laws.

9" chrome-lined, heavy-phosphate-coated S2W-profile barrel and Pistol length gas system deliver subsonic & supersonic projectiles with precision

MFR XL 15.0 Rail features KeyMod attachment points on both sides and the bottom and an extended 1913 rail on top

Fully integrated stainless steel suppressor is pinned and welded for fulltime suppressed fire and extends barrel length to NFA-required 16"



MK18



This short-barreled rifle is unmatched in size, weight, and performance. The MK18 RIS II Rail System features the patented Bolt-Up attachment system and has been rigorously tested prior to fielding by USSOCOM. Class III dealers only; all NFA rules apply.

This firearm is a regulated item by the National Firearms Act (NFA). Please check with your local and state municipalities for any further regulatory requirements. It is the buyer's responsibility to make sure they comply with all NFA rules and applicable laws.

Carbine length gas system with pinned low-profile gas block for reliable cycling

10.3" chrome-lined, heavy-phosphate-coated Government-profile lbarrel provides outstanding maneuverability & durability

Equipped with the same Rail Interface System handguard chosen by USSOCOM for CQB operations around the world



MK12



This "special purpose" firearm was designed to bridge the gap between short-range utility rifles and a long-range precision rifles. With its 18" stainless-steel barrel and Rifle length gas system, which significantly reduces recoil, it is accurate out to 600 yards or more.

Geissele SSA two-stage trigger features crisp break and quick reset for precise fire and faster follow-up shots

Rifle length gas system with MK12 gas block is built to Naval Surface Warfare Center Crane Division specs

18" DLC-coated MK12-profile barrel delivers outstanding accuracy and durability



M4A1



This ready-for-anything, fast-handling rifle is the same high-performance firearm we offer the U.S. military. It features a 14.5" barrel inside the RIS II Rail System that's been trusted for use by U.S. Special Operations Command (SOCOM) since 2006.

Free-floating, battle-tested RIS II Rail System provides real estate for accessories without affecting barrel harmonics

14.5" chrome-lined, heavy-phosphate-coated M4-profile barrel features a pinned & welded DD Flash Suppressor to extend length to NFA-required 16"

Carbine length gas system with pinned low-profile gas block provides reliable cycling



SEE FIREARMS LINEUP:
DANIELDEFENSE.COM/RIFLES



RIGHT ON TARGET WITH PRECISION SHOOTERS

DANIEL DEFENSE® 7.62 MM / 6.5 CREEDMOOR / .260 REM. FIREARMS

Precision shooters place a premium on accuracy—including the accuracy of claims made by rifle manufacturers. Which is why our AR-10-style DD5 rifles are so popular with this discerning group of marksmen. Available in three popular calibers and four barrel lengths to provide even greater long-range precision shooting capability, every DD5 rifle is manufactured from the finest materials and components and painstakingly assembled to deliver legendary Daniel Defense performance and quality with every shot fired.

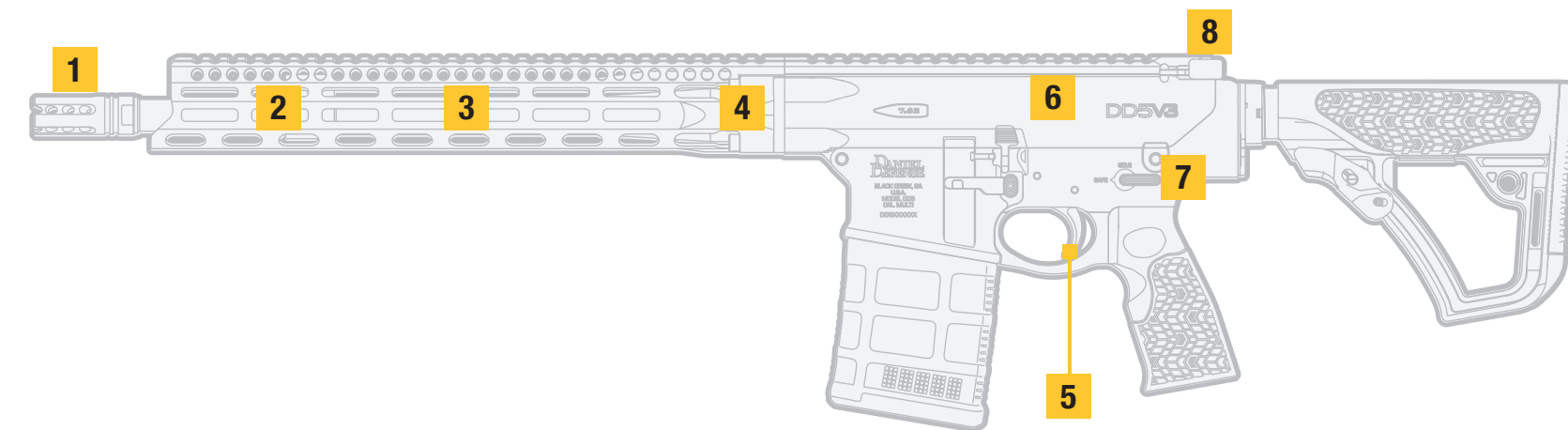

1 SUPERIOR SUPPRESSION DEVICE
Designed to offer reduced muzzle flash signature and muzzle climb



2 ADJUSTABLE GAS BLOCK
Designed to provide consistent and reliable suppressed shooting



3 COLD HAMMER FORGED
Intense hydraulic pressure process that forms the most accurate and longest-lasting barrels attainable



4 INNOVATIVE 4-BOLT CONNECTION SYSTEM
Designed to ensure greater accuracy



5 UPGRADED TRIGGER (HUNTER RIFLES ONLY)
Geissele SSA 2-Stage Trigger for precise fire control



6 SUPERFINISHED & DLC BOLT CARRIER GROUP
Buffer added to optimize cycling and improve recoil impulse



7 FULLY AMBI CONTROLS
Allows for maximum operator flexibility and comfort



8 GRIP-N-RIP® CHARGING HANDLE
Independently ambi charging handle with anti-gas features for a better shooting experience

**DD5[®]SBR**

Black



With a 12.5" barrel, an overall length of only 33", and a weight of just 8.2 lbs., this 7.62 DD5 SBR may just be the ultimate rancher gun. It's easy to stow or carry and features a Mid-length gas system that reduces unlocking pressure as much as possible to accommodate 7.62 rounds. Can't you see one in your truck?

Innovative 4-Bolt Connection System replaces barrel nut for increased stability and a uniform connection between the handguard, barrel, and receiver

Bolt carrier is equipped with a buffer for optimized cycling and improved recoil impulse

12.5" chrome-lined DD proprietary steel, heavy phosphate coated, S2W profile barrel for accuracy and durability; crowned with a DD Linear Compensator

**DD5V3**

Black



When we set out to create a 7.62mm rifle fit to wear the Daniel Defense name, we cleared the drawing board and created an entirely new evolution of the AR-10 platform. Packed full of innovative features that enhance handling, durability and performance, and built to the same legendary quality of our DDM4 carbines.

User-adjustable gas block on DD5s enables consistent and reliable suppressed shooting

Fully ambi safety selector, magazine catch, and bolt release provide maximum operator flexibility and comfort

16" chrome-lined DD proprietary steel, heavy phosphate-coated, S2W-profile barrel for accuracy & durability

**DD5V4**

MIL SPEC +®

Black



The DD5 V4, chambered in either 6.5 Creedmoor or 7.62x51mm NATO, provides users of the Daniel Defense semi-automatic platform even greater long-range precision shooting capability. The highly popular 6.5 Creedmoor takes advantage of superior ballistic coefficients to offer both flatter trajectories and reduced wind drift at levels normally reserved for much heavier recoiling long-action calibers.

Innovative 4-Bolt Connection System replaces barrel nut for increased stability and a uniform connection between the handguard, barrel, and receiver

18" chrome-lined, heavy-phosphate-coated S2W-profile barrel for accuracy and extended range

Independently ambi GRIP-N-RIP Charging Handle has anti gas features for a better shooting experience

**DD5V5**

MIL SPEC +®

Black



The DD5 V5, chambered in either 6.5 Creedmoor or .260 Remington, provides users of the Daniel Defense semi-automatic platform even greater long-range precision shooting capability by featuring two of the top short-action cartridges available for today's modern long-range shooters.

A feature-rich set comes with all DD5s, so it's like getting a rifle that's already been customized by experts

20" chrome-lined DD proprietary steel, heavy phosphate-coated, S2W-profile barrel for accuracy & durability

DD5s accept all SR25 magazines



SEE FIREARMS LINEUP:
DANIELDEFENSE.COM/RIFLES



AR-STYLE HUNTING RIFLES: THE BEST OF BOTH WORLDS

DANIEL DEFENSE® 5.56 MM / .300 BLACKOUT / 6.8 SPC / .260 REM / 6.5 CM FIREARMS

Hunting is all about opportunity, so when we saw an opportunity to take the best aspects of our proven AR rifles and incorporate them into a line of world-class hunting rifles, we seized it. The end result is a rifle that's modular and adjustable for customization and a tailored fit. With substantially less recoil than a traditional bolt-action, you can focus all your attention on your target instead of bracing for impact. And should your first fired round fail to bring down your quarry, faster follow-up shots will help you get the job done and make the most of your opportunity.



DDM4[®] HUNTER  Kryptek Highlander[®]



Designed for your choice of game, the DDM4 Hunter line of rifles boast Daniel Defense quality and performance in three popular hunting calibers. The Hunter 5.56 NATO offers precision and accuracy with a wide range of popular 5.56mm ammo, while the Hunter 300 BLK is chambered in the versatile .300 Blackout cartridge with a wide selection of projectiles. The Hunter 6.8 SPC features the modern SPEC II chamber dimensions to function safely with higher-pressure loads designed to bring down larger prey. Our advanced gas system ensures smooth, reliable cycling, and a crisp 2-Stage Geissele trigger delivers on-target shots to take down that trophy animal you've been tracking.

Free-floating MFR 15.0 rail system features M-LOK attachment technology for weight savings and plenty of accessory real estate without interfering with barrel harmonics

Upgraded trigger: Crisp 2-Stage Geissele Super Semi-Automatic Trigger delivers precise, on-target shots

Chrome-lined, heavy-phosphate-coated S2W-profile barrel for precision accuracy



DD5. V4. HUNTER / .260 REMINGTON



DD5. V4. HUNTER / 6.5 CM



DD5. V4. HUNTER / .308 WIN



DD5 V4 HUNTER



Kryptek Highlander®



This hard-hitting, fast-handling rifle was built with the North American hunter in mind because it's capable of taking down any big-game animal on the continent. Chambered in three popular calibers—.260 Remington, 6.5 Creedmoor, and .308 Winchester—this long-range precision shooter helps you harvest that trophy animal you've been dreaming about. All in a semi-automatic platform with an adjustable gas block, for a consistent feel shooting both suppressed and unsuppressed, and a perfected bolt carrier group that operates flawlessly in all conditions and reduces overall recoil.

User-adjustable gas block for reliable suppressed shooting

Upgraded trigger: Crisp 2-Stage Geissele Super Semi-Automatic Trigger delivers precise, on-target shots

18" chrome-lined DD proprietary steel, heavy phosphate-coated, S2W-profile barrel for accuracy & durability

DD5. V5. HUNTER / .260 REMINGTON



DD5. V5. HUNTER / 6.5 CREEDMOOR



DD5 V5 HUNTER



Kryptek Highlander®



Chambered in either 6.5 Creedmoor or .260 Remington, this hunting phenom stretches the effective range of our semi-automatic platform out to even greater distances—approaching 1,000 meters—by utilizing two of today's top short-action cartridges for long-range hunting. With an adjustable gas block allowing for a consistent feel shooting both suppressed and unsuppressed, and a perfected bolt carrier group that reduces recoil and is easy to maintain and operate in all conditions, that trophy animal in your sights won't know what hit it. But hit it you will, because this remarkable rifle is a flat-out hunting machine.

20" chrome-lined DD proprietary steel, heavy phosphate-coated, S2W-profile barrel for accuracy & durability

Fully ambi safety selector, magazine catch, and bolt release provide maximum operator flexibility and comfort

4-Bolt Connection System: Free-floating CHF barrel and handguard mount securely to the upper without a barrel nut

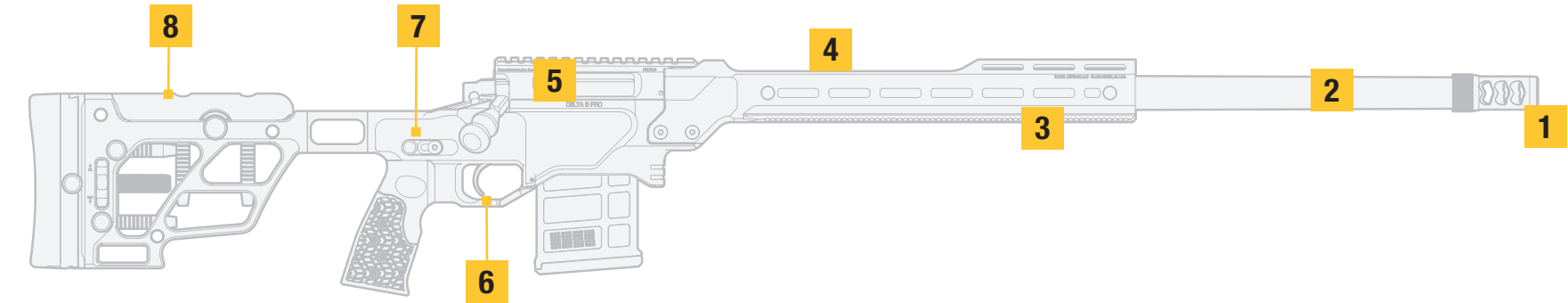

1 SUB-MOA ACCURACY GUARANTEE

DELTA 5 Pro rifles are guaranteed to shoot .5 MOA or less at 100 yards (DELTA 5 .75 MOA) when used with quality factory match-grade ammunition



2 PROPRIETARY COLD HAMMER FORGED STEEL BARREL

Manufacturing processes paired with the highest-quality material to give you a lifetime of accuracy and durability; modularity allows for barrels to be easily swapped to different calibers without needing a gunsmith



4 20 MOA SCOPE MOUNT/ SCALLOPED CUT

Less scope adjustment needed for greater long-range accuracy; scalloped cut allows for lower height over bore even with scopes with large objective lenses



3 MODULAR, COMPETITION-READY CHASSIS

Upgraded features that ensure peak performance while eliminating the need for a gunsmith and the added cost of aftermarket parts



5 STAINLESS STEEL ACTION

Designed to function in all weather conditions, tighter tolerances in the action give you a more accurate and consistent performance; patent-pending bolt stop allows for easy, snag-free operation while the three-lug bolt with 60-degree throw helps you get off more shots faster



6 TIMNEY ELITE HUNTER TRIGGER

Adjustable single-stage with two-position safety (1.5 - 4 lbs.)



7 ERGONOMIC THUMB REST

For maximum comfort and control; left/right adjustability to accommodate the user's preference

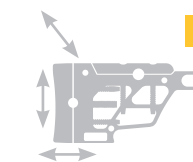

8 FULLY ADJUSTABLE STOCK

Comb/cheek piece is adjustable for height and yaw; controlled by knob/spring vise for easy adjustment and to hold the setting when released

THE MOST ACCURATE PRODUCTION RIFLE IN THE WORLD

DANIEL DEFENSE® .308 WIN / 6MM / 6.5 CREEDMOOR / .260 REM. FIREARMS

Talk is cheap unless it's backed up by testing, data, and results that back it up. So, when we say that all Daniel Defense DELTA 5 rifles are guaranteed to shoot .75 MOA or less at 100 yards when used with quality factory match-grade ammunition—and all Daniel Defense DELTA 5 Pro rifles are guaranteed to shoot .5 MOA or less under the same conditions—know that we've put in the work to substantiate these claims. So you can fire with confidence, knowing your rifle is more than up to the task at hand.



DELTA 5® / .308 WIN



DELTA 5® / .308 WIN



DELTA 5® / 6.5 CREEDMOOR

(scope not included)



DELTA 5® / 6.5 CREEDMOOR



DELTA 5 PRO



The ultimate package of performance, accuracy, and custom features rarely found on a production bolt gun. The DELTA 5 PRO bridges the gap between basic platforms and more expensive custom builds. Whether you're a casual weekend shooter or a seasoned competitor, this rifle will grow right along with your skillset because it's guaranteed to shoot sub half MOA. It's also one of the first production rifles to sport Area 419's ARCA Rail. But the one thing you won't find on this competition-ready rifle is a hefty competition price tag.

FULL-LENGTH ARCA RAIL
Integral to the chassis, the locking system extends the entire length of the forend; one-piece design increases rigidity on the RRS-compatible system

ULTIMATE MUZZLE BRAKE
Area 419 HELLFIRE Muzzle Brake features rearward-facing ports for the ultimate in recoil reduction and muzzle-rise mitigation

INTERCHANGEABLE BARREL
Forged to contour from a proprietary steel blend with a Cerakote finish. Replace barrels or change calibers with ease thanks to its modularity and proprietary barrel nut

DELTA 5 PRO



How do you improve upon the design of our winning DELTA 5 Pro rifles? By offering shorter barrels better suited for law enforcement and other users who don't need longer barrels to make extreme long-range shots. The DELTA 5 Pro offers multiple barrel lengths ranging from 16" and 18", to 24" and 26", and calibers including .308 Win, 6.5 Creedmoor and 6 MM Creedmoor. And the barrels on both are fully interchangeable, so you can easily swap barrels and change calibers. Everything else is pure DELTA, including they're guaranteed to shoot .5 MOA or less.

FULL-LENGTH ARCA RAIL
Integral to the chassis, the locking system extends the entire length of the forend; one-piece design increases rigidity on the RRS-compatible system

ULTIMATE MUZZLE BRAKE
Area 419 HELLFIRE Muzzle Brake features rearward-facing ports for the ultimate in recoil reduction and muzzle-rise mitigation

INTERCHANGEABLE BARREL
Forged to contour from a proprietary steel blend with a Cerakote finish; replace barrels or change calibers with ease thanks to its modularity and proprietary barrel nut



0.75 MOA
ACCURACY GUARANTEE



SEE FIREARMS LINEUP:
DANIELDEFENSE.COM/RIFLES

DELTA 5® / .308 WIN



DELTA 5® / 6.5 CREEDMOOR



DELTA 5  Black



Designed with the user in mind, Daniel Defense has taken the modularity of the AR platform and integrated it into a one-of-a-kind bolt-action rifle. From an interchangeable cold hammer forged barrel to a user-configurable stock, the DELTA 5 features out-of-the-box customization that typically requires professional gunsmithing. For the user that expects more from their rifle, the DELTA 5 provides the ultimate long-range shooting experience from the day it's purchased. No custom wait time required. Barrel Conversion Kits also available.

TRIGGER

Adjustable single-stage Timney Elite Hunter with two-position safety (1.5 – 4 lbs)

20 MOA SCOPE MOUNT

Compensates for bullet drop variance between the barrel and scope mount, therefore, less scope adjustment is needed for greater long-range accuracy

ADJUSTABLE STOCK

Out-of-the-box easy adjustability and comfort make it easy for shooters of all skill levels to achieve maximum performance and accuracy; carbon-fiber-reinforced polymer construction ensures a lifetime of service

NEW

PRO CHASSIS SYSTEM ACCESSORIES

FOR DELTA 5® OR REMINGTON 700 ACTION



BAG RIDER

Extends surface area for contact with the rear bag; eliminates bag hook catching the bag



EXTENDED PICATINNY RAIL

Extends length of available rail to end of handguard; one-piece design creates coaxial alignment; allows use of forward mounted optic

Stable shooting platform and ability to move forward and backward without moving the bag



NEW

PRO CHASSIS SYSTEM

FOR DELTA 5® OR REMINGTON 700 ACTION



A competitive option for Remington 700 rifles. This chassis is a drop-in replacement for bolt-action rifles with the R700 Action footprint. Designed for long-range competition, its integral features give users a professional chassis solution without the professional price tag. With innovative features like the adjustable thumb rest, integral ARCA Rail and user-adjustable buttstock, the PRO Chassis System will take your 700 to the next level of performance.

FULLY ADJUSTABLE STOCK

Comb/cheek piece is adjustable for height and yaw; controlled by knob/spring vise for easy adjustment and to hold the setting when released

FULL-LENGTH ARCA RAIL

Integral to the chassis, the locking system extends the entire length of the forend; one-piece design increases rigidity on the RRS-compatible system

THUMB REST

Left/right adjustment allows users to set the desired position for optimal ergonomics





DB[®]



SEE SUPPRESSOR LINEUP:
DANIELDEFENSE.COM/SOUNDGUARD



DANIEL
SOUNDGUARD
POWERED BY KGM

LESS BLOWBACK, MORE SHOTS ON TARGET

Daniel SoundGuard Powered by KGM Suppressors are proof positive that less truly can be more. These hardcore, well-balanced suppressors powered by KGM technology significantly reduce impulse noise levels, allowing shooters to perform at the highest levels while protecting against hearing loss. A patented baffle stack and proprietary material coating of internal parts reduce a weapon's flash signature to virtually zero, while cutting-edge gas-flow design eliminates over-gassing and decreases toxic gasses directed at a shooter. There's even an adjustable port endcap on our Titanium suppressor that allows for maximum recoil reduction regardless of the firearm's caliber or configuration. All with minimum point-of-impact shift and maximum satisfaction guaranteed—as in 100 percent, just like you get with every product worthy of the Daniel Defense name.



Adjustable-Port Endcap available on SG-30Ti



1 EXTREME ACCURACY

Patent-pending gas-flow pathing stabilizes rounds and provides negligible point-of-impact shift



2 NO GAS BLOWBACK

Cutting-edge gas-flow design eliminates over-gassing and decreases toxic gases directed at a shooter



3 SOUND REDUCTION

Significantly reduces impulse noise levels, protecting against hearing loss



4 FLASH REDUCTION

Patented baffle stack design and proprietary material coating reduces a firearm's flash signature to virtually zero



SOUNDGUARD™ DT SUPPRESSOR ADAPTER 1/2" - 28"

SG-556™

- + .223 / 5.56mm
- + 22.0 oz (w/ mount)
- + 7" length
- + 1.75" tube diameter
- + Stainless-steel baffle stack and tube
- + 1/2 x 28" TPI



SOUNDGUARD™ DT SUPPRESSOR ADAPTER 5/8" - 24"

SG-30™

- + .223 Rem – 300 PRC
- + 22.5 oz (w/ mount)
- + 7" length
- + 1.75" tube diameter
- + Stainless-steel baffle stack and tube
- + 5/8 x 24" TPI



SOUNDGUARD™ DT TITANIUM SUPPRESSOR ADAPTER 5/8" - 24"

SG-30Ti™

- + .223 Rem – 300 PRC
- + 15.0 oz (w/ mount)
- + 7.75" length
- + 1.75" tube diameter
- + Titanium baffle stack and tube
- + 5/8 x 24" TPI



Compatible adapters: YHM Kurtz, Silencer Co ASR, Dead Air Xeno & Keymo, Area 419 Hellfire





SEE ALL UPPER RECEIVERS:
DANIELDEFENSE.COM/UPPERS



UPPERS THAT WON'T LET YOU DOWN

A quality AR-15-style rifle build demands a top-shelf upper, and Daniel Defense Upper Receiver Groups are the industry gold standard. Precision manufactured at our Georgia plant out of the finest materials to the tightest tolerances, every URG comes standard with a bolt carrier group and a charging handle. They also feature an adjustable gas block for reliable suppressed shooting without missing a beat. Available in multiple calibers for a wide range of firearms, trust that a Daniel Defense upper will not let you down.

RIII™ NEW UPPER RECEIVER GROUPS

DD4™ RIII™ S

- + 5.56 NATO (5.56x45mm)
- + 1.7", 11.5" CHF GOV-Profile Barrel
- + DD Flash Suppressor
- + Carbine Gas System
- + Low-Profile Gas Block
- + RIS III 10.5 Rail System
- + M16 Bolt Carrier Group
- + GRIP-N-RIP Charging Handle
- + Available in Black or FDE/Black



DD4™ RIII™

- + 5.56 NATO (5.56x45mm)
- + 1.7", 16" CHF GOV-Profile Barrel
- + DD Flash Suppressor
- + Mid-Length Gas System
- + Low-Profile Gas Block
- + RIS III 12.5 Rail System
- + M16 Bolt Carrier Group
- + GRIP-N-RIP Charging Handle
- + Available in Black or FDE/Black



MK18 RIII™

- + 5.56 NATO (5.56x45mm)
- + 1.7", 10.3" CHF GOV-Profile Barrel
- + DD Flash Suppressor
- + Carbine Length Gas System
- + Low-Profile Gas Block
- + RIS III 9.5 Rail System
- + M16 Bolt Carrier Group
- + GRIP-N-RIP Charging Handle
- + All NFA Rules Apply
- + Available in Black or FDE/Black



M4A1 RIII™

- + 5.56 NATO (5.56x45mm)
- + 1.7", 14.5" CHF GOV-Profile Barrel
- + DD Flash Suppressor
- + Mid-Length Gas System
- + Low-Profile Gas Block
- + RIS III 12.5 Rail System
- + M16 Bolt Carrier Group
- + GRIP-N-RIP Charging Handle
- + Available in Black or FDE/Black





DDM4[®] UPPER RECEIVER GROUPS

M4A1

- + 5.56 NATO (5.56x45mm)
- + 1.7", 14.5" CHF M4-Profile Barrel
- + Pinned & Welded DD Flash Suppressor
- + Carbine Length Gas System
- + Low-Profile Gas Block
- + M4A1 RIS II FDE Rail System
- + M16 Bolt Carrier Group
- + GRIP-N-RIP Charging Handle



DDM4[®]V7[®]

- + 5.56 NATO (5.56x45mm)
- + 1.7", 16" CHF GOV-Profile Barrel
- + DD Flash Suppressor
- + Mid-Length Gas System
- + Low-Profile Gas Block
- + MFR 15.0 Rail System
- + M16 Bolt Carrier Group
- + GRIP-N-RIP Charging Handle



DDM4[®]V7[®] LW

- + 5.56 NATO (5.56x45mm)
- + 1.7", 16" CHF LW-Profile Barrel
- + DD Flash Suppressor
- + Mid-Length Gas System
- + Low-Profile Gas Block
- + MFR 15.0 Rail System
- + M16 Bolt Carrier Group
- + GRIP-N-RIP Charging Handle



DDM4[®]V7[®] PRO

- + 5.56 NATO (5.56x45mm)
- + 1.7", 18" CHF S2W-Profile Barrel
- + DD Muzzle Climb Mitigator
- + Rifle Length Gas System
- + Low-Profile Gas Block
- + MFR 15.0 Rail System
- + M16 Bolt Carrier Group
- + GRIP-N-RIP Charging Handle



DDM4[®].300S

- + .300 Blackout (7.62x35mm)
- + 1.8", 10.3" CHF S2W-Profile Barrel
- + DD Flash Suppressor
- + Pistol Length Gas System
- + Low-Profile Gas Block
- + DDM4 Rail 9.0
- + M16 Bolt Carrier Group
- + Daniel Defense Vertical Grip
- + GRIP-N-RIP Charging Handle
- + All NFA Rules Apply



DDM4[®]V4[®]S

- + 5.56 NATO (5.56x45mm)
- + 1.7", 11.5" CHF GOV-Profile Barrel
- + DD Flash Suppressor
- + Carbine Length Gas System
- + Low-Profile Gas Block
- + DDM4 Rail 10.0
- + M16 Bolt Carrier Group
- + Daniel Defense Vertical Grip
- + GRIP-N-RIP Charging Handle
- + All NFA Rules Apply



MK18

- + 5.56 NATO (5.56x45mm)
- + 1.7", 10.3" CHF GOV-Profile Barrel
- + DD Flash Suppressor
- + Carbine Length Gas System
- + Low-Profile Gas Block
- + MK18 RIS II FDE or Black Rail System
- + M16 Bolt Carrier Group
- + GRIP-N-RIP Charging Handle
- + All NFA Rules Apply



MK12

- + 5.56 NATO (5.56x45mm)
- + 1.7", 18" CHF MK12-Profile Stainless-Steel Barrel
- + DD Flash Suppressor
- + Rifle Length Gas System
- + MK12 Gas Block
- + DDM4 Rail 12.0
- + M16 Bolt Carrier Group
- + GRIP-N-RIP Charging Handle





SEE ALL RAIL SYSTEMS:
DANIELDEFENSE.COM/RAILS



DANIEL DEFENSE RAIL SYSTEMS

RUGGED, RELIABLE & VERSATILE

A quality rail is not only essential for accuracy and maneuverability of an AR-style rifle, it also plays an integral part in accessorizing and customizing your firearm to truly make it yours. Daniel Defense incorporates the finest materials, cutting-edge technology, state-of-the-art manufacturing techniques, and legendary quality control to manufacture a wide selection of the finest rail systems on Earth.

Our free-floating design contributes to a rifle's accuracy because it doesn't affect a barrel's harmonics. And our patented Bolt-Up System securely attaches the handguard to the upper receiver. The bottom line is, no matter which DD rail system you select, you've made an outstanding choice that enhances your rifle.

RIS III™ RAILS NEW

The Daniel Defense RIS III Rail Interface System takes the proven design of our two-piece RIS II rails—used by U.S. Special Operations Command (SOCOM) since 2006—and reduces weight while adding versatility by utilizing M-LOK attachment. You get the same proven free-float barrel design, durable aircraft-grade aluminum construction, and an uninterrupted upper rail platform with Mil-Spec 1913 rail of the RIS II. But you also get seven M-LOK attachment points along the handguard, plus integral QD swivel attachment points on both sides.

- + Free-Floating Barrel Design for Increased Accuracy
- + M-LOK Attachment at 7 Different Positions Along Length of Handguard
- + Aircraft Grade 6061-T6 Aluminum Construction
- + Proven 6-Bolt Bolt-Up System Securely Attaches Handguard to the Upper Receiver
- + Grade 8 Military Specification Fasteners
- + Uninterrupted Upper Rail Platform & Mil-Spec 1913 Picatinny Rail
- + Backward Compatible with RIS II Bolt-Up System—Utilizes Same Barrel Nut & Bolt-Up Plate
- + RIS III Upper Rail Is Fully Compatible with RIS II Lower Rail

RIS III™ 9.5



Designed to work with standard carbine gas systems or over a low-profile gas block on pistol length gas systems

- + Weight: 12.93 oz
- + Length: 9.5"
- + Width: 1.95"
- + Inside Diameter: 1.42"
- + Available in FDE or Black



RIS III™ 10.5



Designed to work with standard carbine gas systems or over a low-profile gas block on pistol length gas systems

- + Weight: 13.7 oz
- + Length: 10.5"
- + Width: 1.95"
- + Inside Diameter: 1.42"
- + Available in FDE or Black



RIS III™ 12.5



Compatible with low-profile gas blocks on pistol, carbine, mid-length, and rifle length gas systems

- + Weight: 16.61 oz
- + Length: 12.5"
- + Width: 1.95"
- + Inside Diameter: 1.42"
- + Available in FDE or Black



RIS III™ 13.0 FSP

Compatible with front site base on carbine length gas system

- + Weight: 16.38 oz
- + Length: 13.0"
- + Width: 1.95"
- + Inside Diameter: 1.42"
- + Available in FDE or Black





MFR RAIL

Daniel Defense MFR Rail Systems utilize M-LOK attachment for incredible weight savings as well as superior cooling, ergonomics, and modularity—all while maintaining the strength and durability expected from Daniel Defense. A sleek Bolt-Up System increases strength and reduces the overall diameter of the rail, making it easier to control while still utilizing a standard Bolt-Up System Barrel Nut. These versatile rail systems can be used with a pinned low-profile gas block on pistol, carbine, mid-length, or rifle length gas systems.

- + Lightweight Free-Floating Barrel Design
- + Uninterrupted Mil-Spec 1913 Picatinny Upper Rail
- + M-LOK Attachments in 7 Different Positions
- + Configurable Sling Swivel Attachment Points
- + Patented Bolt-Up Mounting System

MFR RAIL 9.0

Compatible with low-profile gas blocks on pistol and carbine length gas systems

- + Weight: 5.4 oz
- + Length: 9.04"
- + Width: 1.56"
- + Inside Diameter: 1.39"



MFR RAIL 10.0

Compatible with low-profile gas blocks on pistol, carbine, and mid-length gas systems

- + Weight: 6.2 oz
- + Length: 10.58"
- + Width: 1.56"
- + Inside Diameter: 1.39"



MFR RAIL 13.5

Compatible with low-profile gas blocks on pistol, carbine, mid-, and rifle length gas systems

- + Weight: 8.0 oz
- + Length: 13.79"
- + Width: 1.56"
- + Inside Diameter: 1.39"



MFR RAIL 15.0

Compatible with low-profile gas blocks on pistol, carbine, mid-, and rifle length gas systems

- + Weight: 10.1 oz
- + Length: 15.34"
- + Width: 1.56"
- + Inside Diameter: 1.39"



MFR XL RAIL

Our MFR XL Rail Systems utilize M-LOK attachment for incredible weight savings, superior cooling, ergonomics, and modularity with no sacrifice in strength or durability. M-LOK attachment points are located along the sides and bottom of the rail, and there's an uninterrupted 1913 Picatinny rail on top. Our sleek Bolt-Up System increases strength and allows for easy installation, while an increased internal diameter gives the operator the ability to reflex some suppressors underneath the rail system. MFR XL rails are compatible with a pinned low-profile gas block on pistol, carbine, mid-length, or rifle length gas systems.

- + Lightweight Free-Floating Barrel Design
- + Uninterrupted Mil-Spec 1913 Picatinny Upper Rail
- + M-LOK Attachment Points on the Sides and Bottom
- + Patented Bolt-Up System and Hardened-Steel Barrel Nut
- + 1.61" Internal Diameter Designed for Use with Suppressor

MFR XL RAIL 9.0

Compatible with low-profile gas blocks on pistol and carbine length gas systems

- + Weight: 6.25 oz
- + Length: 9.15"
- + Width: 1.82"
- + Inside Diameter: 1.61"



MFR XL RAIL 10.0

Compatible with low-profile gas blocks on pistol, carbine, and mid-length gas systems

- + Weight: 7.05 oz
- + Length: 10.38"
- + Width: 1.82"
- + Inside Diameter: 1.61"



MFR XL RAIL 13.5

Compatible with low-profile gas blocks on pistol, carbine, mid-length, and rifle length gas systems

- + Weight: 9.4 oz
- + Length: 13.79"
- + Width: 1.82"
- + Inside Diameter: 1.61"



MFR XL RAIL 15.0

Compatible with low-profile gas blocks on pistol, carbine, mid-length, and rifle length gas systems

- + Weight: 10.4 oz
- + Length: 15.30"
- + Width: 1.82"
- + Inside Diameter: 1.61"





RIS II RAIL

The Rail Interface System Daniel Defense has provided to U.S. Special Operations Command (SOCOM) since 2006. This revolutionary two-piece handguard attaches to the receiver with our patented, 6-bolt Bolt-Up System and free floats the barrel. Available in your choice of Flat Dark Earth or Black.

- + Free-Floating Barrel Design For Increased Accuracy
- + Two-Piece Design for USSOCOM Allows for Lower Rail Section Detachment (M4A1 RIS II Only).
- + Proven 6-Bolt Bolt-Up System Securely Attaches Handguard to the Upper Receiver
- + Grade 8 Military Specification Fasteners
- + Uninterrupted Upper Rail Platform & Mil-Spec 1913 Picatinny Rails
- + Mil-Spec Type III Hard Coat Anodized Finish (FDE or Black)
- + The Daniel Defense RIS II M4A1 FSP Features a Cutout in the Top Rail to Accommodate a Standard Front Sight Base on a Carbine Length Gas System

MK18 RIS II RAIL



Compatible with low-profile gas block on pistol and carbine gas systems

- + Weight: 14.1 oz
- + Length: 9.55"
- + Width: 2.23"
- + Inside Diameter: 1.15"
- + Available in FDE or Black



M4A1 RIS II RAIL



Compatible with low-profile gas block on pistol, carbine and mid-length gas systems

- + Weight: 17.7 oz
- + Length: 12.25"
- + Width: 2.23"
- + Inside Diameter: 1.15"
- + Available in FDE or Black



M4A1 FSP RIS II RAIL



Compatible with front sight base on carbine length gas systems

- + Weight: 17.1 oz
- + Length: 12.25"
- + Width: 2.23"
- + Inside Diameter: 1.15"
- + Available in FDE or Black



DDM4. RAIL

The Daniel Defense DDM4 Rail features an optimized one-piece, free-floating architecture, resulting in the ergonomics and durability users demand without sacrificing maneuverability because of added weight. Limited-rotation QD swivel attachment points are located at the front and rear of both sides of this rail system for tangle-free sling attachment, and a continuous Picatinny rail on top provides ample real estate for sights and accessories.

- + Lightweight Free-Floating Barrel Design
- + Mil-Spec 1913 Picatinny Rails on Sides, Top & Bottom
- + Aircraft-Grade 6061-T6 Aluminum Construction with Hardened-Steel Barrel Nut
- + Four Ambidextrous Sling Swivel Attachment Points at 3 and 9 O'clock
- + Patented Bolt-Up Mounting System
- + Mil-Spec Type III Hard Coat Anodized Finish

DDM4. RAIL 9.0



Compatible with front sight base gas blocks at mid-length, and low-profile gas blocks on pistol and carbine length gas systems

- + Weight: 9.5 oz
- + Length: 9.24"
- + Width: 1.90"
- + Inside Diameter: 1.08"

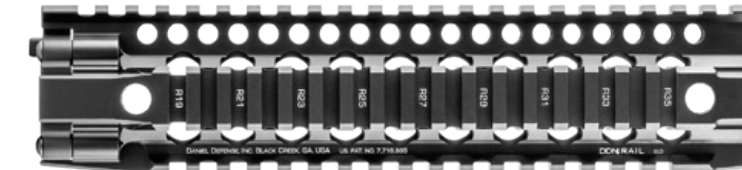

DDM4. RAIL 10.0



Compatible with low-profile gas blocks on pistol, carbine, and mid-length gas systems

- + Weight: 10.2 oz
- + Length: 10.06"
- + Width: 1.90"
- + Inside Diameter: 1.08"

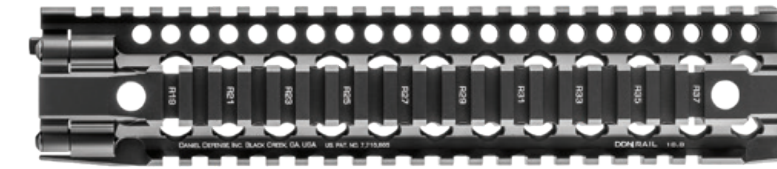

DDM4. RAIL 12.0



Compatible with front sight base gas blocks at rifle length or over a low-profile gas block on pistol, carbine, and mid-length gas systems

- + Weight: 12.4 oz
- + Length: 12.43"
- + Width: 1.90"
- + Inside Diameter: 1.08"

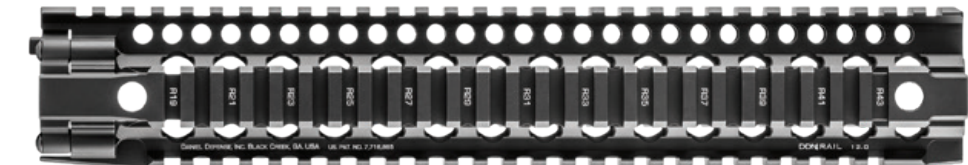

DDM4. RAIL 15.0



Compatible with low-profile gas blocks on pistol, carbine, mid-length, and rifle length gas systems

- + Weight: 14.8 oz
- + Length: 15.20"
- + Width: 1.90"
- + Inside Diameter: 1.08"

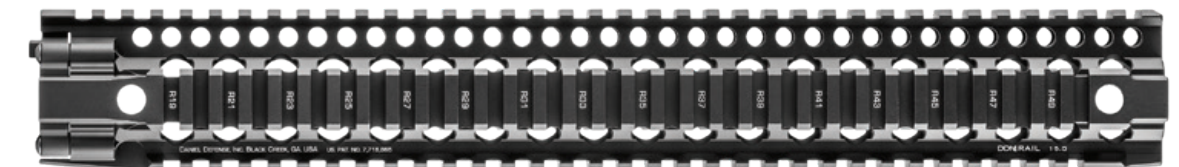



OMEGA RAIL®

Omega Rail is specifically engineered to satisfy the intense demands of the military and law enforcement communities. This free-float option accommodates individual operator installation and requires ZERO modification to the host weapon. It also allows those who have delta ring assemblies to free float their barrel. The Omega Rail is designed to work with all commercially available M4 or AR-15 gas systems. Its exceptional strength-to-weight ratio makes it the perfect selection as a replacement for plastic handguards for your M4 or AR-15-style weapon.

- + Lightweight Free-Floating Barrel Design
- + Easy to Install, Requires No Special Tools and No Modification to Host Weapon
- + Uninterrupted Mil-Spec 1913 Picatinny Upper Rail
- + Integral QD Sling Swivel Mounts with Limited-Rotation Feature
- + Aircraft-Grade Aluminum Construction with Mil-Spec Fasteners
- + Mil-Spec Type III Hard Coat Anodized Finish

OMEGA RAIL® 7.0

Designed to work with standard carbine gas systems or over a low-profile gas block on pistol length gas systems

- + Weight: 7.6 oz
- + Length: 6.87"
- + Width: 1.90"

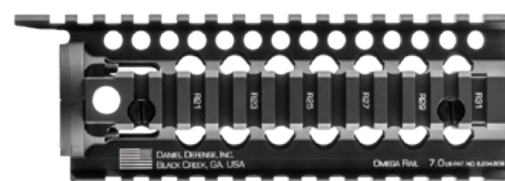

OMEGA RAIL® 9.0

Designed to work with standard mid-length gas systems or over a low-profile gas block on pistol and carbine length gas systems

- + Weight: 9.8 oz
- + Length: 8.88"
- + Width: 1.90"

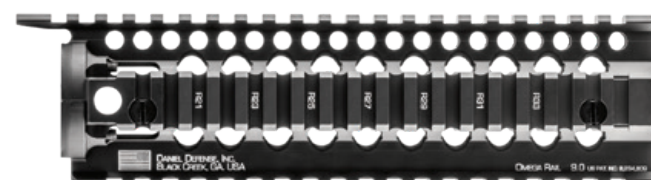

OMEGA RAIL® 7.0

Designed to work with standard carbine gas systems or over a low-profile gas block on pistol length gas systems

- + Weight: 6.7 oz
- + Length: 7.02"
- + Width: 1.85"



OMEGA RAIL® 9.0

Designed to work with standard mid-length gas systems or over a low-profile gas block on pistol and carbine length gas systems

- + Weight: 8.2 oz
- + Length: 8.99"
- + Width: 1.85"



WATCH OMEGA RAIL® INSTALLATION
WWW.YOUTUBE.COM/DANIELDEFENSE





SEE ALL BARRELS:
DANIELDEFENSE.COM/BARRELS

CHF BARRELS



Cold Hammer Forging (CHF) produces the most accurate, longest-lasting rifle barrels. In early 2009, after months of research and development and labor-intensive testing, Daniel Defense introduced one of the only commercially available 5.56mm Cold Hammer Forged barrels in the United States. After fine-tuning the manufacturing process and proving these barrels to be some of the most accurate and durable available, Daniel Defense introduced an entire line of Cold Hammer Forged barrels.

The process is accomplished through intense hydraulic pressure applied at opposing angles by carbide steel hammers. During the hammering process, a mandrel is inserted into the bore while the carbide steel hammers shape the barrel around the mandrel, creating the chamber, the lands, and the grooves. The Cold Hammer Forging process also changes the micro-structure of the steel, making it stronger, with a defect-free bore and the most consistent chamber possible.

All Daniel Defense barrels are Cold Hammer Forged and made from start to finish in our state-of-the-art facility located in Black Creek, Georgia. With the capacity to manufacture several thousand barrels each and every month, quality-control standards have never been more crucial. Sophisticated equipment, such as the Hommel optic, Micro-VU, and bore scope, is used routinely for complex measurements, ensuring each barrel is to spec. Daniel Defense barrels are finished with either a Mil-Spec heavy-phosphate outer finish with chrome lining or DLC coating as it pertains to the MK12 stainless steel barrel. DELTA 5 barrels are Cerakote H-Series coated.

BARREL PROFILES

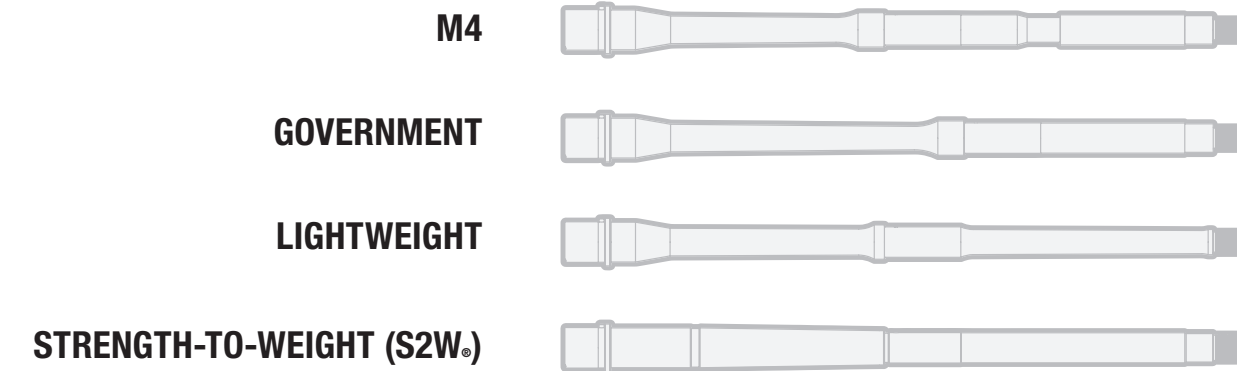

GAS SYSTEM LENGTH*

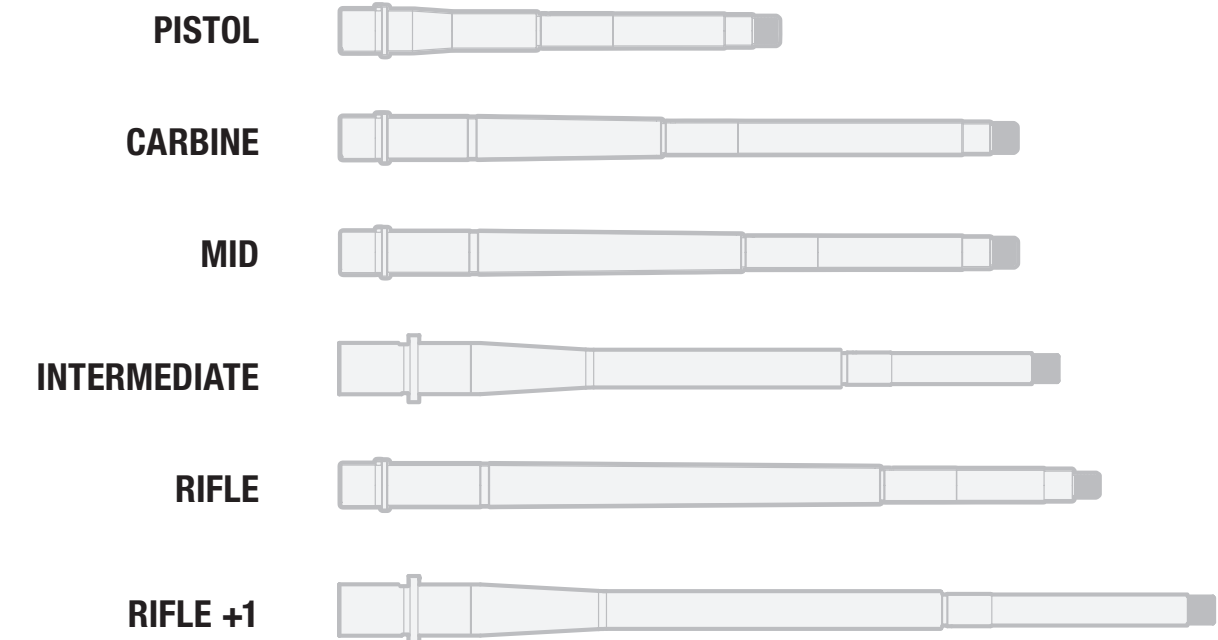

* Gas system barrel length applies to DDM4, DD4 RIII, and DD5 platforms.





DELTA 5® CHF BARRELS

Our Cold Hammer Forged barrels are as accurate and long lasting as any you'll find. And you can easily switch the caliber of your DELTA 5 or DELTA 5 Pro with a barrel conversion kit. We've taken the modularity found in our ARs and adopted it for the bolt-action rifle by attaching the barrel via a barrel extension. Since the extensions are installed at our factory, headspace will always be correct because it is set at the time of manufacturing. To change barrels, just remove the barreled action, remove the barrel nut, install the new barrel, tighten the barrel nut to the proper torque, and then re-install the entire barrel/action assembly into the stock. With the included ½" barrel nut wrench, you can swap barrels in minutes. No gunsmith required!

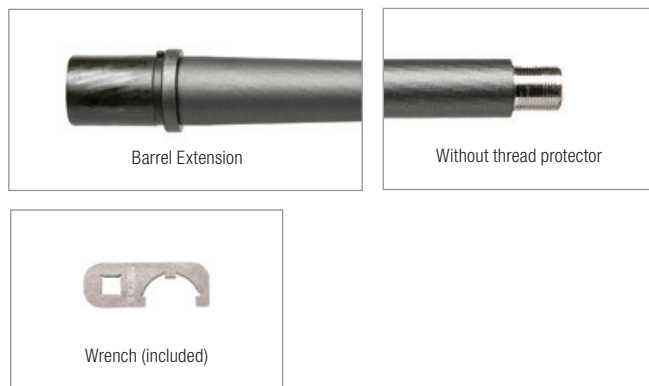

DELTA 5® BARRELS		
16" DELTA 5®, VARMINT + .308 Win., 1:10" Twist	20" DELTA 5®, HEAVY PALMA + .308 Win., 1:10" Twist	26" DELTA 5®, VARMINT + 6mm Creedmoor, 1:7.5" Twist
18" DELTA 5®, VARMINT + 6.5 Creedmoor, 1:8" Twist	24" DELTA 5®, HEAVY PALMA + 6.5 Creedmoor, 1:8" Twist	26" DELTA 5®, VARMINT + 6.5 Creedmoor, 1:8" Twist

CHF BARRELS

CMV (Chrome Moly Vanadium), CHF (Cold Hammer Forged), chrome-lined phosphate finish unless noted in description

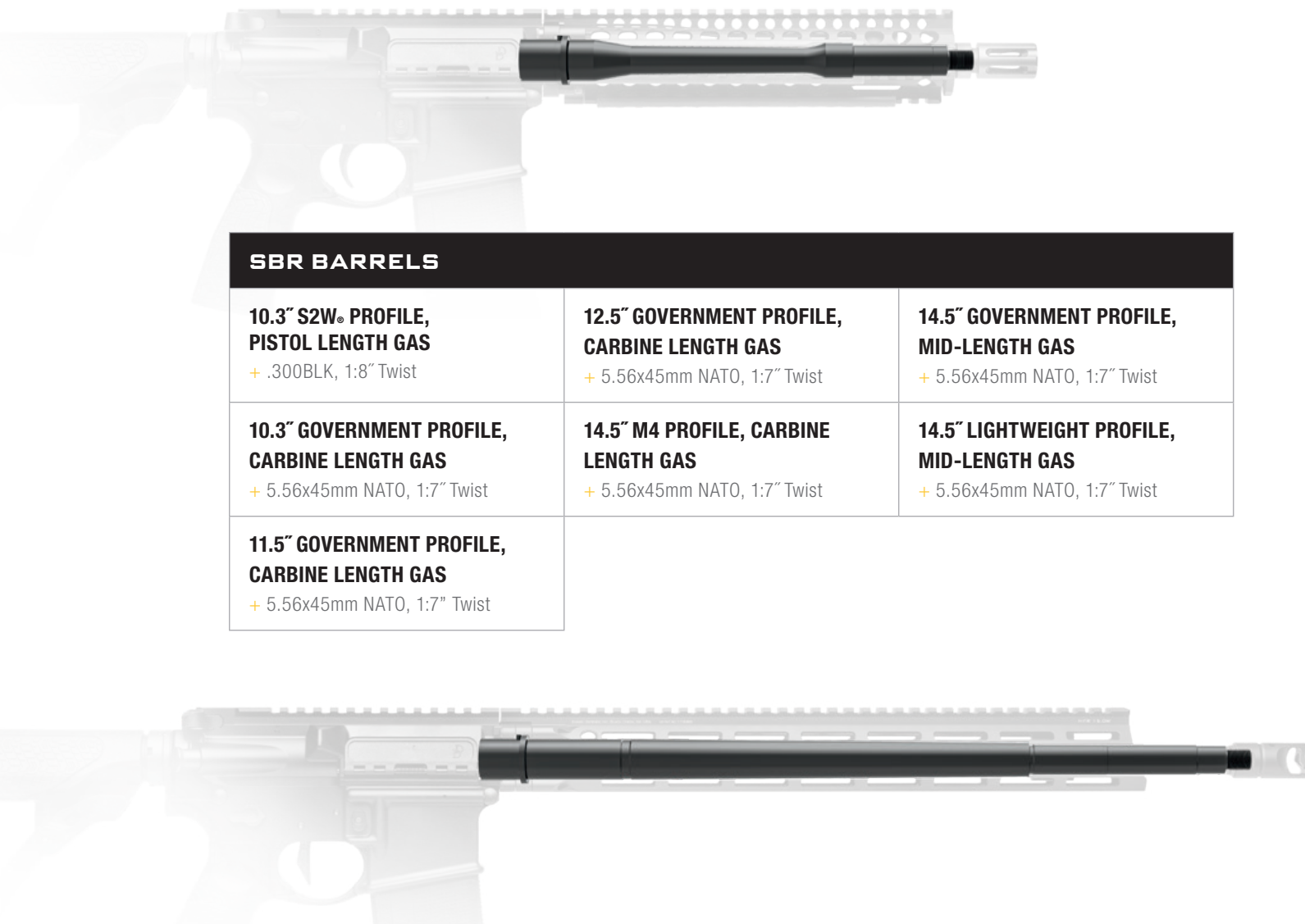

SBR BARRELS		
10.3" S2W® PROFILE, PISTOL LENGTH GAS + .300BLK, 1:8" Twist	12.5" GOVERNMENT PROFILE, CARBINE LENGTH GAS + 5.56x45mm NATO, 1:7" Twist	14.5" GOVERNMENT PROFILE, MID-LENGTH GAS + 5.56x45mm NATO, 1:7" Twist
10.3" GOVERNMENT PROFILE, CARBINE LENGTH GAS + 5.56x45mm NATO, 1:7" Twist	14.5" M4 PROFILE, CARBINE LENGTH GAS + 5.56x45mm NATO, 1:7" Twist	14.5" LIGHTWEIGHT PROFILE, MID-LENGTH GAS + 5.56x45mm NATO, 1:7" Twist
11.5" GOVERNMENT PROFILE, CARBINE LENGTH GAS + 5.56x45mm NATO, 1:7" Twist		

16-18" BARRELS		
16" M4 PROFILE, CARBINE LENGTH GAS + 5.56x45mm NATO, 1:7" Twist	16" S2W® PROFILE, CARBINE LENGTH GAS + .300BLK, 1:8" Twist	18" S2W® PROFILE, MID-LENGTH GAS + 5.56x45mm NATO, 1:7" Twist
16" GOVERNMENT PROFILE, MID-LENGTH GAS + 5.56x45mm NATO, 1:7" Twist	16" S2W® PROFILE, MID-LENGTH GAS + 6.8 SPCII, 1:11" Twist	18" S2W® PROFILE, MID-LENGTH GAS + 6.8 SPCII, 1:11" Twist
16" LIGHTWEIGHT PROFILE, MID-LENGTH GAS + 5.56x45mm NATO, 1:7" Twist	18" S2W® PROFILE, RIFLE LENGTH GAS + 5.56x45mm NATO, 1:7" Twist	18" SS MK12 PROFILE, RIFLE LENGTH GAS* + 5.56x45mm NATO, 1:7" Twist, DLC coated



SEE ALL PARTS & ACCESSORIES:
DANIELDEFENSE.COM/ACCESSORIES



ENHANCED FURNITURE



DD. ENHANCED VERTICAL GRIP

Daniel Defense Enhanced Vertical Grip includes soft-touch rubber overmolding for enhanced grip, wet or dry. Dual O-ring, watertight storage compartment is capable of storing small parts (Picatinny version only). Extremely lightweight and utilizes a simple yet durable mounting method.



MIL SPEC +[®] Black



DD. ENHANCED PISTOL GRIP

Daniel Defense Enhanced Pistol Grip features a more ergonomic wrist angle and option with or without integral trigger guard for strength and comfort. Soft-touch rubber overmolding gives the shooter a reliable hold in all weather conditions.

MIL SPEC +[®] Black



DD. ENHANCED BUTTSTOCK

The Daniel Defense Enhanced Buttstock is constructed of a proprietary blend of glass-infused polymers and finished off with soft-touch rubber overmolding in strategic points. It's precision formed for Mil-Spec receiver extensions, minimizing forward or lateral play. This eliminates the need for a tensioning device or friction lock. All of this results in a durable buttstock that provides a comfortable, repeatable cheek weld and unprecedented firearm control. The buttstock can be run with the included convex or concave buttpads or without them to accommodate the operator's gear. Integrated, limited-rotation QD swivel attachment points on both sides for ambidextrous sling attachment.

MIL SPEC +[®] Black





MUZZLE DEVICES

QUALITY, STRENGTH, & DURABILITY

Daniel Defense offers premium muzzle device options that are designed, tested, and manufactured to meet the expectations of the most experienced shooters. In a series of tests, the Daniel Defense Flash Suppressor and Superior Suppression Device showed reduced muzzle signature over the traditional A2 Birdcage. For competition shooters demanding accuracy, the Daniel Defense Muzzle Climb Mitigator redirects propellant gasses through calibrated ports, countering both recoil and muzzle climb. Less recoil and muzzle climb result in quicker, more precise follow-up shots and reduced fatigue. In keeping with the highest standard of quality, Daniel Defense muzzle devices are constructed from the highest-grade 17-4 PH stainless steel and salt-bath-nitride finished to reduce corrosion and wear.

Daniel Defense muzzle devices are available in 1/2-28 (5.56mm) or 5/8-24 (6.8 SPCII, 300 BLK, 7.62mm) TPI. Only the Flash Suppressor and SSD come in standard or extended lengths. The standard-length flash suppressor, 1/2-28 TPI, is compatible with certain aftermarket sound suppressors.



FLASH SUPPRESSOR

- + Length: 1.875"
- + Weight: 2.27 oz.
- + TPI: 1/2-28 or 5/8-24



FS EXTENDED

- + Length: 2.250"
- + Weight: 2.66 oz.
- + TPI: 1/2-28



SSD EXTENDED

- + Length: 2.250"
- + Weight: 2.89 oz.
- + TPI: 1/2-28



SUPERIOR SUPPRESSION DEVICE

- + Length: 1.875"
- + Weight: 2.38 oz.
- + TPI: 1/2-28 or 5/8-24



MUZZLE CLIMB MITIGATOR

- + Length: 2.125"
- + Weight: 3.21 oz.
- + TPI: 1/2-28 or 5/8-24



DD. WAVE. MUZZLE BRAKE

- + Length: 2.23"
- + Weight: 3.84 oz.
- + TPI: 1/2-28 or 5/8-24





DELTA 5. ACCESSORIES



BAG RIDER

FOR DELTA 5® PRO & PRO CHASSIS SYSTEM

Extends surface area for contact with the rear bag. Eliminates bag hook catching the bag. Stable shooting platform and ability to move forward and backward without moving the bag.



EXTENDED PICATINNY RAIL

FOR DELTA 5® PRO

Extends length of available rail to end of handguard. One-piece design creates coaxial alignment. Allows use of forward mounted optic.



NEW

FOLDING STOCK

FOR DELTA 5® PRO & R700 CHASSIS SYSTEMS

Installs in minutes and allows the buttstock to fold in, reducing chassis size. Once folded, there's no movement, rattling, or metal-on-metal contact. Made with sturdy stainless-steel and no-button, its tapered lock provide the strongest possible lockup.



A1.5. FIXED REAR SIGHT

The Daniel Defense fixed rear sight with patented Rock & Lock technology allows for easy and secure installation on flat-top upper receivers. It is engineered to not impede use of the charging handle on AR-15-style rifles.

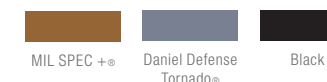

FIXED FRONT SIGHT

Special attention was paid to facilitate the use of a light forward of this rail-mounted fixed front sight. Rear surface features anti-glare serrations. One-piece design ensures easy installation with its patented Rock & Lock technology.



GRIP-N-RIP. CHARGING HANDLE

Supercharge your AR with the Daniel Defense GRIP-N-RIP Charging Handle, designed and manufactured with the features and benefits to enhance every user's comfort and performance. The GRIP-N-RIP is engineered for suppressed fire. Independently ambidextrous handles accommodate left- and right-handed shooters, with each handle independently operating the latch.



RAIL PANELS

Made for MIL-STD 1913 Picatinny rail systems, these rail panels are designed to shield your hand from excessive heat while protecting the rail system. Made from Santoprene, a material capable of withstanding temperatures up to 300° Fahrenheit. Will not fit KeyMod or M-LOK rail systems. Available in black and come three to a pack.



DD MAGAZINE.

There's only one brand of magazine worthy of the Daniel Defense name. Built with legendary quality, it holds 32 rounds of 5.56mm while remaining the same size as industry-standard 30-round magazines. Available in single or 12-pack.



NEW

DD. M-LOK. HANDSTOP

Provides a consistent point of reference on your forend rail for gripping your rifle with the support hand. Its low-profile, ergonomic design provides a secure grip, while its textured front serves as a barricade stop to ensure your firearm remains stable during firing and prevents your hand from sliding forward toward the muzzle.



MOUNTS



M-LOK. SCOUT LIGHT. MOUNT

Developed for the SureFire Scout Light. Lightweight, snag-free design is compatible with M-LOK handguards and is reversible for ambidextrous use. Will securely attach the SureFire M300 Mini Scout Light, M600 Ultra Scout Light, M600P Fury Scout Light, M300V Mini Scout Light, M600V Scout Light.



MICRO MOUNT

Securely mount a variety of popular optics, including Aimpoint's Micro R-1, H-1, T-1, T-2; Vortex's Sparc I & II; Primary Arms' Micro Dot & Advanced Micro Dot; Holosun Technologies HS403; or any other optic using the same type of mounting method. Offers absolute or lower 1/3 co-witness with backup iron sights. Patented Rock & Lock attachment technology.



M-LOK. TO PICATINNY (MIL-STD 1913 RAIL) MOUNT

The Daniel Defense M-LOK Picatinny Rail Section is a 2.5" M1913 Rail designed to attach to an M-LOK Handguard. This part allows for the installation of any Picatinny accessory, such as vertical grips, lights, and sling attachments.



1 O'CLOCK OFFSET RAIL

Optimized for mounting miniature red-dot optics or a variety of lights and accessories in the 1 o'clock (right-hand) or 11 o'clock (left-hand) positions. Patented Rock & Lock attachment technology.



M-LOK. QD ATTACHMENT POINT

M-LOK QD Swivel Attachment Point is designed to allow the mounting of a popular heavy-duty pushbutton quick detach sling swivel anywhere along a handguard with M-LOK attachment. Molded from robust 4620 steel and finished with magnesium-phosphate coating to protect against corrosion and wear, the M-LOK QD Attachment Point is designed to limit the swivel's rotation to prevent twisting or tangling of the sling.



RAIL MOUNT QD SWIVEL ATTACHMENT

Mount the swivel anywhere along the rail system with the Rail Mount QD Swivel Attachment. Machined to limit the rotation of the swivel to prevent the operator's sling from becoming tangled. One-piece design increases structural integrity. QD Swivel included. Patented Rock & Lock attachment technology.

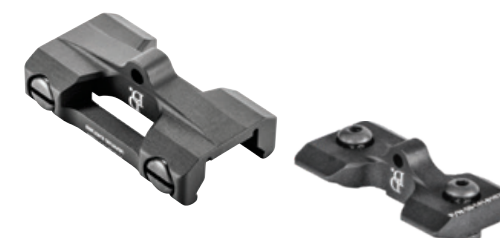

BIPOD MOUNT ADAPTER

The Daniel Defense Bipod Mount Adapter is designed for use on rail systems that utilize the M-LOK or Picatinny attachment method for mounting accessories. This lightweight adapter allows users to securely attach bipods with sling swivel stud mounts. Available in Rock & Lock (Picatinny) or M-LOK versions.



OPTICS MOUNTS

Get secure mounting for most standard-size scopes with our Optics Mounts. Available in single-ring and variable-power scope configurations, the mounts are precision-machined from 6061-T6 Aluminum and finished with Type III Hard Coat Anodizing. Each mount features our patented Rock & Lock technology for easy installation and removal with Torx Plus fasteners at the base and rings. Available in both 1" and 30mm.



REAR RECEIVER QD SWIVEL ATTACHMENT

QD Swivel Attachment provides an ambidextrous pushbutton attachment of the popular heavy-duty pushbutton QD sling swivel. This steel-constructed swivel attachment mounts to the rear of the AR-15 lower receiver with a collapsible stock receiver extension. The swivel's rotation is limited by the buffer tube, preventing tangles.



EZ CAR. SLING MOUNT

Attaches to any AR-15/M4 with a collapsible buttstock and Mil-Spec receiver extension. QD swivel attachment allows for ambidextrous functionality as the QD swivel can be swapped from the left attachment point to right and rotation is limited to ensure the sling does not become twisted or tangled. One-piece design allows for quick and easy installation.



DDM4 [®] RIFLES	MFR #	CALIBER	RAIL SYSTEM	LENGTH	WEIGHT	GAS	BARREL	BARREL PROFILE	TWIST	MUZZLE DEVICE	BLACK	MIL SPEC +	DD TORNADO	DEEP WOODS	FLAT DARK EARTH	KRY HIGHLANDER	COBALT	GUN METAL GRAY	RATTLECAN
DDM4V1	02-050-15027	5.56 NATO	DDM4 RAIL 12.0 FSP	32 1/4" - 35 7/8"	6.70 LBS	CARBINE	16"	M4	1:7"	IMPROVED FLASH SUPPRESSOR	•								
DDM4V4 S	02-088-11034	5.56 NATO	DDM4 RAIL 10.0	27 7/8" - 31 1/4"	5.85 LBS	CARBINE	11.5"	GOVERNMENT	1:7"	IMPROVED FLASH SUPPRESSOR	•								
DDM4V7	02-128-02081-047	5.56 NATO	MFR 15.0	32 1/4" - 35 7/8"	6.20 LBS	MID	16"	GOVERNMENT	1:7"	IMPROVED FLASH SUPPRESSOR	•								
	02-128-02338-047	5.56 NATO	MFR 15.0	32 1/4" - 35 7/8"	6.20 LBS	MID	16"	GOVERNMENT	1:7"	IMPROVED FLASH SUPPRESSOR	•								
	02-128-13192-047	5.56 NATO	MFR 15.0	32 1/4" - 35 7/8"	6.20 LBS	MID	16"	GOVERNMENT	1:7"	IMPROVED FLASH SUPPRESSOR			•						
	02-128-02267-047	5.56 NATO	MFR 15.0	32 1/4" - 35 7/8"	6.20 LBS	MID	16"	GOVERNMENT	1:7"	IMPROVED FLASH SUPPRESSOR								•	
	02-128-10290-047	5.56 NATO	MFR 15.0	32 1/4" - 35 7/8"	6.20 LBS	MID	16"	GOVERNMENT	1:7"	IMPROVED FLASH SUPPRESSOR				•					
	02-128-10093-047	5.56 NATO	MFR 15.0	32 1/4" - 35 7/8"	6.20 LBS	MID	16"	GOVERNMENT	1:7"	IMPROVED FLASH SUPPRESSOR							•		
DDM4V7 SLW	02-128-15049-047	5.56 NATO	MFR 13.5	31 1/2" - 34 3/4"	5.90 LBS	MID	14.5"	GOVERNMENT	1:7"	IMPROVED FLASH SUPPRESSOR EXT, PINNED & WELDED	•								
DDM4V7 PRO	02-128-16541-047	5.56 NATO	MFR 15.0	34 3/4" - 37 7/8"	7.40 LBS	RIFLE	18"	S2W	1:7"	MUZZLE CLIMB MITIGATOR	•								
	02-128-09385-047	5.56 NATO	MFR 15.0	34 3/4" - 37 7/8"	7.40 LBS	RIFLE	18"	S2W	1:7"	MUZZLE CLIMB MITIGATOR								•	
DDM4V7 S	02-128-07344-047	5.56 NATO	MFR 10.0	27 7/8" - 31 1/4"	5.80 LBS	CARBINE	11.5"	GOVERNMENT	1:7"	IMPROVED FLASH SUPPRESSOR	•								
DDM4V7 HUNTER	02-128-81702-047	5.56 NATO	MFR 15.0	33 3/8" - 37"	7.00 LBS	MID	18"	S2W	1:7"	THREAD PROTECTOR						•			
	02-128-30075-047	300BLK	MFR 15.0	32 1/4" - 35 7/8"	6.55 LBS	CARBINE	16"	S2W	1:8"	THREAD PROTECTOR						•			
	02-128-01078-047	6.8MM SPC	MFR 15.0	33 3/8" - 37"	6.90 LBS	MID	18"	S2W	1:11"	THREAD PROTECTOR						•			
DDM4V9	02-145-15175-047	5.56 NATO	DDM4 RAIL 15.0	32 1/4" - 35 7/8"	6.59 LBS	MID	16"	GOVERNMENT	1:7"	IMPROVED FLASH SUPPRESSOR	•								
DDM4300 S	02-122-17026-047	300BLK	DDM4 RAIL 9.0	26 3/4" - 29 7/8"	5.77 LBS	PISTOL	10.3"	S2W	1:8"	IMPROVED FLASH SUPPRESSOR	•								
DDM4ISR	02-103-02041-047	300BLK	MFR XL 15.0	31 1/2" - 34 3/4"	7.57 LBS	PISTOL	9"	S2W	1:8"	INTEGRATED SUPPRESSOR	•								
	02-103-15139-047	300BLK	MFR XL 15.0	31 1/2" - 34 3/4"	7.57 LBS	PISTOL	9"	S2W	1:8"	INTEGRATED SUPPRESSOR		•							
	02-103-01056-047	300BLK	MFR XL 15.0	31 1/2" - 34 3/4"	7.57 LBS	PISTOL	9"	S2W	1:8"	INTEGRATED SUPPRESSOR				•					
DDM4 PDW SBR	02-088-22220-047	300BLK	MFR XL 6.0	21"	5.7 LBS	PISTOL	7"	S2W	1:7"	DD LINEAR COMPENSATOR	•								
	02-088-04228-047	300BLK	MFR XL 6.0	21"	5.7 LBS	PISTOL	7"	S2W	1:7"	DD LINEAR COMPENSATOR							•		
	02-088-03085-047	300BLK	MFR XL 6.0	21"	5.7 LBS	PISTOL	7"	S2W	1:7"	DD LINEAR COMPENSATOR					•				
M4A1	02-088-06027-011	5.56 NATO	M4A1 RIS II	31 1/2" - 34 3/4"	6.74 LBS	CARBINE	14.5"	M4	1:7"	IMPROVED FLASH SUPPRESSOR EXT, PINNED & WELDED						•			
	02-088-15126-011	5.56 NATO	M4A1 RIS II	31 1/2" - 34 3/4"	6.74 LBS	CARBINE	14.5"	M4	1:7"	IMPROVED FLASH SUPPRESSOR EXT, PINNED & WELDED		•							
MK12	02-142-13175-047	5.56 NATO	DDM4 RAIL 12.0	34 3/4" - 37 7/8"	7.41 LBS	RIFLE	18"	MK12	1:7"	IMPROVED FLASH SUPPRESSOR	•								
	02-088-07327	5.56 NATO	MK18 RIS II	26 3/4" - 29 7/8"	5.88 LBS	CARBINE	10.3"	GOVERNMENT	1:7"	IMPROVED FLASH SUPPRESSOR	•								
	02-088-15028-011	5.56 NATO	MK18 RIS II	26 3/4" - 29 7/8"	5.88 LBS	CARBINE	10.3"	GOVERNMENT	1:7"	IMPROVED FLASH SUPPRESSOR		•							
MK18	02-088-17024	5.56 NATO	MK18 RIS II	26 3/4" - 29 7/8"	5.88 LBS	CARBINE	10.3"	GOVERNMENT	1:7"	IMPROVED FLASH SUPPRESSOR					•				

DD4 [™] RIII [™] RIFLES	MFR #	CALIBER	RAIL SYSTEM	LENGTH	WEIGHT	GAS	BARREL	BARREL PROFILE	TWIST	MUZZLE DEVICE	BLACK	MIL SPEC +	DD TORNADO	DEEP WOODS	FLAT DARK EARTH	KRY HIGHLANDER
DD4 RIII	02-191-03270-047	5.56 NATO	RIS III 12.5	32 1/4" - 35 7/8"	6.52 LBS	MID	16"	GOVERNMENT	1:7"	IMPROVED FLASH SUPPRESSOR						•
DD4 RIII	02-191-10750-047	5.56 NATO	RIS III 12.5	32 1/4" - 35 7/8"	6.52 LBS	MID	16"	GOVERNMENT	1:7"	IMPROVED FLASH SUPPRESSOR	•					
DD RIII S	02-088-30095-047	5.56 NATO	RIS III 10.5	27 7/8" - 31 1/4"	5.92 LBS	CARBINE	11.5"	GOVERNMENT	1:7"	IMPROVED FLASH SUPPRESSOR						•
DD RIII S	02-191-12105-047	5.56 NATO	RIS III 10.5	27 7/8" - 31 1/4"	5.92 LBS	CARBINE	11.5"	GOVERNMENT	1:7"	IMPROVED FLASH SUPPRESSOR	•					
M4A1 RIII	02-191-04238-047	5.56 NATO	RIS III 12.5	31 1/2" - 34 3/4"	6.39 LBS	MID	14.5"	GOVERNMENT	1:7"	IMPROVED FLASH SUPPRESSOR, EXT						•
M4A1 RIII	02-191-10613-047	5.56 NATO	RIS III 12.5	31 1/2" - 34 3/4"	6.39 LBS	MID	14.5"	GOVERNMENT	1:7"	IMPROVED FLASH SUPPRESSOR, EXT	•					
MK18 RIII	02-088-00319-047	5.56 NATO	RIS III 9.5	26 3/4" - 29 7/8"	5.73 LBS	CARBINE	10.3"	GOVERNMENT	1:7"	IMPROVED FLASH SUPPRESSOR						•
MK18 RIII	02-088-10401-047	5.56 NATO	RIS III 9.5	26 3/4" - 29 7/8"	5.73 LBS	CARBINE	10.3"	GOVERNMENT	1:7"	IMPROVED FLASH SUPPRESSOR	•					

DD5 [™] RIFLES	MFR #	CALIBER	RAIL SYSTEM	LENGTH	WEIGHT	GAS	BARREL	BARREL PROFILE	TWIST	MUZZLE DEVICE	BLACK	MIL SPEC +	DD TORNADO	DEEP WOODS	FLAT DARK EARTH	KRY HIGHLANDER
DD5 SBR	02-088-06071-047	.308 WIN	DD5 RAIL 15.0	30.38" - 33.63"	8.2 LBS	MID	12.5"	S2W	1:10"	DD LINEAR COMPENSATOR	•					
DD5V3	02-157-07258-047	.308 WIN	DD5 RAIL 15.0	33 3/8" - 37"	8.35 LBS	RIFLE	16"	S2W	1:10"	DD SUPERIOR SUPPRESSION DEVICE	•					
DD5V4	02-158-13210-047	.308 WIN	DD5 RAIL 15.0	35 3/8" - 39"	8.60 LBS	RIFLE	18"	S2W	1:10"	DD SUPERIOR SUPPRESSION DEVICE	•					
	02-158-15060-047	.308 WIN	DD5 RAIL 15.0	35 3/8" - 39"	8.60 LBS	RIFLE	18"	S2W	1:10"	DD SUPERIOR SUPPRESSION DEVICE		•				
	02-158-22207-047	.6.5 CREEDMOOR	DD5 RAIL 15.0	35 3/8" - 39"	8.60 LBS	RIFLE	18"	S2W	1:8"	DD SUPERIOR SUPPRESSION DEVICE	•					
	02-158-20057-047	.6.5 CREEDMOOR	DD5 RAIL 15.0	35 3/8" - 39"	8.60 LBS	RIFLE	18"	S2W	1:8"	DD SUPERIOR SUPPRESSION DEVICE		•				
DD5V4 HUNTER	02-158-23069-047	.308 WIN	DD5 RAIL 15.0	35 3/8" - 39"	8.60 LBS	RIFLE	18"	S2W	1:10"	DD SUPERIOR SUPPRESSION DEVICE						•
	02-158-09282-047	.6.5 CREEDMOOR	DD5 RAIL 15.0	35 3/8" - 39"	8.60 LBS	RIFLE	18"	S2W	1:8"	DD SUPERIOR SUPPRESSION DEVICE						•
	02-158-00300-047	.260 REMINGTON	DD5 RAIL 15.0	35 3/8" - 39"	8.60 LBS	RIFLE	18"	S2W	1:7"	DD SUPERIOR SUPPRESSION DEVICE						•
DD5V5	02-165-30063-047	.6.5 CREEDMOOR	DD5 RAIL 15.0	38 3/8" - 41 5/8"	8.90 LBS	RIFLE + 1"	20"	S2W	1:8"	DD SUPERIOR SUPPRESSION DEVICE	•					
	02-165-81690-047	.6.5 CREEDMOOR	DD5 RAIL 15.0	38 3/8" - 41 5/8"	8.90 LBS	RIFLE + 1"	20"	S2W	1:8"	DD SUPERIOR SUPPRESSION DEVICE		•				
	02-165-01229-047	.260 REMINGTON	DD5 RAIL 15.0	38 3/8" - 41 5/8"	8.90 LBS	RIFLE + 1"	20"	S2W	1:7"	DD SUPERIOR SUPPRESSION DEVICE	•					
DD5V5 HUNTER	02-165-09377-047	.6.5 CREEDMOOR	DD5 RAIL 15.0	38 3/8" - 41 5/8"	8.90 LBS	RIFLE + 1"	20"	S2W	1:8"	DD SUPERIOR SUPPRESSION DEVICE						•
	02-165-17067-047	.260 REMINGTON	DD5 RAIL 15.0	38 3/8" - 41 5/8"	8.90 LBS	RIFLE + 1"	20"	S2W	1:7"	DD SUPERIOR SUPPRESSION DEVICE						•



DELTA 5 [®] BOLT-ACTION RIFLES	MFR #	CALIBER	MOUNTING SYSTEM	LENGTH	WEIGHT	BARREL	BARREL PROFILE	TWIST	MUZZLE	BLACK	OLIVE DRAB	COYOTE TAN
DELTA 5	42-159-07365	6.5mm CREEDMOOR	M-LOK	44"	9.50 LBS	24"	HEAVY PALMA	1:8"	5/8 x 24 TPI	•		
DELTA 5	42-159-07265	.308 WIN	M-LOK	40"	8.90 LBS	20"	HEAVY PALMA	1:10"	5/8 x 24 TPI	•		
DELTA 5 PRO	42-159-07388	.308 WIN	ARCA/M-LOK	36 1/2"	11.4 LBS	16"	VARMINT	1:10"	5/8 x 24 TPI	•		
DELTA 5 PRO	42-159-07288	.308 WIN	ARCA/M-LOK	36 1/2"	11.4 LBS	16"	VARMINT	1:10"	5/8 x 24 TPI			•
DELTA 5 PRO	42-159-10092	.308 WIN	ARCA/M-LOK	36 1/2"	11.4 LBS	16"	VARMINT	1:10"	5/8 x 24 TPI		•	
DELTA 5 PRO	42-159-06238	6.5 CREEDMOOR	ARCA/M-LOK	38 1/2"	11.7 LBS	18"	VARMINT	1:8"	5/8 x 24 TPI	•		
DELTA 5 PRO	42-159-06088	6.5 CREEDMOOR	ARCA/M-LOK	38 1/2"	11.7 LBS	18"	VARMINT	1:8"	5/8 x 24 TPI			•
DELTA 5 PRO	42-159-05238	6.5 CREEDMOOR	ARCA/M-LOK	38 1/2"	11.7 LBS	18"	VARMINT	1:8"	5/8 x 24 TPI		•	
DELTA 5 PRO	42-159-11229	.308 WIN	ARCA/M-LOK	40 1/4"	10.8 LBS	20"	HEAVY PALMA	1:10"	5/8 x 24 TPI	•		
DELTA 5 PRO	42-159-13082	.308 WIN	ARCA/M-LOK	40 1/4"	10.8 LBS	20"	HEAVY PALMA	1:10"	5/8 x 24 TPI			•
DELTA 5 PRO	42-159-12080	.308 WIN	ARCA/M-LOK	40 1/4"	10.8 LBS	20"	HEAVY PALMA	1:10"	5/8 x 24 TPI		•	
DELTA 5 PRO	42-159-10593	6.5 CREEDMOOR	ARCA/M-LOK	44 1/4"	11.4 LBS	24"	HEAVY PALMA	1:8"	5/8 x 24 TPI	•		
DELTA 5 PRO	42-159-11081	6.5 CREEDMOOR	ARCA/M-LOK	44 1/4"	11.4 LBS	24"	HEAVY PALMA	1:8"	5/8 x 24 TPI			•
DELTA 5 PRO	42-159-10730	6.5 CREEDMOOR	ARCA/M-LOK	44 1/4"	11.4 LBS	24"	HEAVY PALMA	1:8"	5/8 x 24 TPI		•	
DELTA 5 PRO	42-159-12079	6.5 CREEDMOOR	ARCA/M-LOK	46 1/4"	13.2 LBS	26"	VARMINT	1:8"	5/8 x 24 TPI	•		
DELTA 5 PRO	42-159-01088	6.5 CREEDMOOR	ARCA/M-LOK	46 1/4"	13.2 LBS	26"	VARMINT	1:8"	5/8 x 24 TPI			•
DELTA 5 PRO	42-159-81712	6.5 CREEDMOOR	ARCA/M-LOK	46 1/4"	13.2 LBS	26"	VARMINT	1:8"	5/8 x 24 TPI		•	
DELTA 5 PRO	42-159-00305	6MM CREEDMOOR	ARCA/M-LOK	46 1/4"	13.3 LBS	26"	VARMINT	1:7.5"	5/8 x 24 TPI	•		
DELTA 5 PRO	42-159-30085	6MM CREEDMOOR	ARCA/M-LOK	46 1/4"	13.3 LBS	26"	VARMINT	1:7.5"	5/8 x 24 TPI			•
DELTA 5 PRO	42-159-23079	6MM CREEDMOOR	ARCA/M-LOK	46 1/4"	13.3 LBS	26"	VARMINT	1:7.5"	5/8 x 24 TPI		•	

DELTA 5 PRO ACCESSORIES	MFR #
BAG RIDER	21-163-17085
EXTENDED PICATINNY BASE	03-088-09490
FOLDING STOCK	21-163-11099-1
REACTION ROD	17-088-07267

PRO CHASSIS SYSTEM	MFR #	BLACK	COYOTE TAN	OLIVE DRAB
DELTA 5	21-163-04231	•		
	21-163-08277		•	
	21-163-19178			•
R700	21-163-10289	•		
	21-163-10389		•	
	21-163-10601			•

UPPER RECEIVERS	MFR #	CALIBER	RAIL SYSTEM	GAS BLOCK	WEIGHT	GAS	BARREL	BARREL PROFILE	TWIST	MUZZLE DEVICE	BLACK	MIL SPEC +	FLAT DARK EARTH
DDM4V7	23-128-02339-047	5.56 NATO	MFR 15.0	LOW PROFILE	4.00 LBS	MID	16"	GOVERNMENT	1:7"	IMPROVED FLASH SUPPRESSOR	•		
DDM4V7 LW	23-128-02932-047	5.56 NATO	MFR 15.0	LOW PROFILE	3.90 LBS	MID	16"	LIGHTWEIGHT	1:7"	IMPROVED FLASH SUPPRESSOR	•		
DDM4V7 PRO	23-128-20044-047	5.56 NATO	MFR 15.0	LOW PROFILE	5.25 LBS	RIFLE	18"	S2W	1:7"	DD MUZZLE CLIMB MITIGATOR	•		
DDM4V7 S	23-128-00275-047	5.56 NATO	MFR 10.0	LOW PROFILE	3.50 LBS	CARBINE	11.5"	GOVERNMENT	1:7"	IMPROVED FLASH SUPPRESSOR	•		
DDM4V9	23-145-18027-047	5.56 NATO	DDM4 RAIL 15.0	LOW PROFILE	4.41 LBS	MID	16"	GOVERNMENT	1:7"	IMPROVED FLASH SUPPRESSOR	•		
M4A1	23-004-13150	5.56 NATO	M4A1 RIS II	LOW PROFILE	4.56 LBS	CARBINE	14.5"	M4	1:7"	IMPROVED FLASH SUPPRESSOR EXT, PINNED & WELDED			•
MK12	23-142-10035	5.56 NATO	DDM4 RAIL 12.0	MK12	5.23 LBS	RIFLE	18"	MK12	1:7"	IMPROVED FLASH SUPPRESSOR	•		
MK18	23-004-08013-006	5.56 NATO	MK18 RIS II	LOW PROFILE	3.50 LBS	CARBINE	10.3"	GOVERNMENT	1:7"	IMPROVED FLASH SUPPRESSOR	•		
	23-004-08013-011	5.56 NATO	MK18 RIS II	LOW PROFILE	3.50 LBS	CARBINE	10.3"	GOVERNMENT	1:7"	IMPROVED FLASH SUPPRESSOR			•
DDM4300 S	23-088-19020-047	300BLK	DDM4 RAIL 9.0	LOW PROFILE	3.65 LBS	PISTOL	10.3"	S2W	1:7"	IMPROVED FLASH SUPPRESSOR	•		
DDM4V4 S	23-088-05147	5.56 NATO	DDM4 RAIL 10.0	LOW PROFILE	4.00 LBS	CARBINE	11.5"	GOVERNMENT	1:7"	IMPROVED FLASH SUPPRESSOR	•		
DD4 RIII	23-191-20088-011	5.56 NATO	RIS III	LOW PROFILE	4.35 LBS	MID	16"	GOVERNMENT	1:7"	IMPROVED FLASH SUPPRESSOR			•
DD4 RIII	23-191-20088-006	5.56 NATO	RIS III	LOW PROFILE	4.35 LBS	MID	16"	GOVERNMENT	1:7"	IMPROVED FLASH SUPPRESSOR	•		
DD4 RIII S	23-191-02397-006	5.56 NATO	RIS III	LOW PROFILE	3.73 LBS	CARBINE	11.5	GOVERNMENT	1:7"	IMPROVED FLASH SUPPRESSOR	•		
DD4 RIII S	23-191-02397-011	5.56 NATO	RIS III	LOW PROFILE	3.73 LBS	CARBINE	11.5	GOVERNMENT	1:7"	IMPROVED FLASH SUPPRESSOR			•
M4A1 RIII	23-004-01097-006	5.56 NATO	RIS III	LOW PROFILE	4.21 LBS	CARBINE	14.5"	GOVERNMENT	1:7"	IMPROVED FLASH SUPPRESSOR EXT, PINNED & WELDED	•		
M4A1 RIII	23-004-01097-011	5.56 NATO	RIS III	LOW PROFILE	4.21 LBS	CARBINE	14.5"	GOVERNMENT	1:7"	IMPROVED FLASH SUPPRESSOR EXT, PINNED & WELDED			•
MK18 RIII	23-004-81721-011	5.56 NATO	RIS III	LOW PROFILE	3.55 LBS	CARBINE	10.3"	GOVERNMENT	1:7"	IMPROVED FLASH SUPPRESSOR			•
MK18 RIII	23-004-81721-006	5.56 NATO	RIS III	LOW PROFILE	3.55 LBS	CARBINE	10.3"	GOVERNMENT	1:7"	IMPROVED FLASH SUPPRESSOR	•		



RAILS	MFR #	WEIGHT	LENGTH	WIDTH	INSIDE DIAMETER
DDM4 RAIL 9.0	01-134-15114	10.3 OZ	9.22"	1.90"	1.08"
DDM4 RAIL 10.0	01-134-08237	11.0 OZ	10.06"	1.90"	1.08"
DDM4 RAIL 12.0	01-134-15163	13.2 OZ	12.43"	1.90"	1.08"
DDM4 RAIL 15.0	01-134-09186	15.6 OZ	15.20"	1.90"	1.08"
OMEGA RAIL 7.0-PICATINNY	01-005-10001	7.6 OZ	6.87"	1.90"	1.08"
OMEGA RAIL 9.0-PICATINNY	01-005-10002	9.8 OZ	8.87"	1.90"	1.08"
OMEGA RAIL 7.0-M-LOK	01-005-10696	6.7 OZ	7.02"	1.85"	1.32"
OMEGA RAIL 9.0-M-LOK	01-005-11047	8.2 OZ	8.99"	1.85"	1.32"
MFR 9.0 M-LOK	01-107-15140	5.4 OZ	9.04"	1.56"	1.39"
MFR 10.0 M-LOK	01-107-09348	6.2 OZ	10.58"	1.56"	1.39"
MFR 13.5 M-LOK	01-107-15189-006	8.0 OZ	13.79"	1.56"	1.39"
MFR 15.0 M-LOK	01-107-16044	10.1 OZ	15.34"	1.56"	1.39"
MFR XL 9.0 M-LOK	01-107-08094	6.25 OZ	9.155"	1.82"	1.61"
MFR XL 10.0 M-LOK	01-107-08198	7.05 OZ	10.38"	1.82"	1.61"
MFR XL 13.5 M-LOK	01-107-08246	9.40 OZ	13.80"	1.82"	1.61"
MFR XL 15.0 M-LOK	01-107-09195	10.40 OZ	15.30"	1.82"	1.61"
MK18 RIS II (FDE)	01-004-08020-011	14.1 OZ	9.55"	2.23"	1.15"
MK18 RIS II (Black)	01-004-08020-006	14.1 OZ	9.55"	2.23"	1.15"
M4A1 RIS II (FDE)	01-004-08001	17.7 OZ	12.25"	2.23"	1.15"
M4A1 RIS II (Black)	1-004-08001-006	17.7 OZ	12.25"	2.23"	1.15"
M4A1 RIS II FSP (FDE)	01-004-08030	17.1 OZ	12.25"	2.23"	1.15"
M4A1 RIS II FSP (Black)	01-004-08030-006	17.1 OZ	12.25"	2.23"	1.15"
RIS III 9.5 (FDE)	01-004-02976-011	12.96 OZ	9.5"	1.95"	1.42"
RIS III 9.5 (Black)	01-004-02976-006	12.96 OZ	9.5"	1.95"	1.42"
RIS III 10.5 (FDE)	01-004-03261-011	13.7 OZ	10.5"	1.95"	1.42"
RIS III 10.5 (Black)	01-004-03261-006	13.7 OZ	10.5"	1.95"	1.42"
RIS III 12.5 (FDE)	01-004-03086-011	16.61 OZ	12.5"	1.95"	1.42"
RIS III 12.5 (Black)	01-004-03086-006	16.61 OZ	12.5"	1.95"	1.42"
RIS III FSP 13.0 (FDE)	01-004-02383-011	16.38 OZ	13.0"	1.95"	1.42"
RIS III FSP 13.0 (Black)	01-004-02383-006	16.38 OZ	13.0"	1.95"	1.42"

FURNITURE	MFR #	BLACK	MIL SPEC +
COLLAPSIBLE BUTTSTOCK	21-091-04179-006	•	
	21-091-04179-011		•
PISTOL GRIP	21-071-05177-006	•	
	21-071-05177-011		•
PICATINNY VERTICAL FOREGRIP	21-067-05028-006	•	
	21-067-05028-011		•
M-LOK VERTICAL FOREGRIP	21-067-19145-006	•	
	21-067-19145-011		•
PICATINNY BUTTSTOCK/PISTOL GRIP/VERTICAL GRIP COMBO	28-102-06145-006	•	
	28-102-06145-011		•
M-LOK BUTTSTOCK/PISTOL GRIP/VERTICAL GRIP COMBO	28-088-12065-006	•	
	28-088-12065-011		•

BARRELS	MFR #	CALIBER	PROFILE	TWIST	GAS SYSTEM	MATERIAL
DELTA 5 24"	41-164-19168	6.5 CREEDMOOR	HEAVY PALMA	1:8"	--	PROPRIETARY STEEL
DELTA 5 20"	34-164-18067	.308 WIN	HEAVY PALMA	1:10"	--	PROPRIETARY STEEL
DELTA 5 16"	34-169-03272	.308 WIN	VARMINT	1:10"	--	PROPRIETARY STEEL
DELTA 5 18"	41-169-17084	6.5 CREEDMOOR	VARMINT	1:8"	--	PROPRIETARY STEEL
DELTA 5 26"	41-169-21153	6.5 CREEDMOOR	VARMINT	1:8"	--	PROPRIETARY STEEL
DELTA 5 26"	45-169-09491	6MM CREEDMOOR	VARMINT	1:7.5"	--	PROPRIETARY STEEL
10.3"	36-116-06191-018	300BLK	S2W	1:8"	PISTOL	CHROME MOLY VANADIUM
	07-077-16176-018	5.56 NATO	GOVERNMENT	1:7"	CARBINE	CHROME MOLY VANADIUM
	07-077-02123	5.56 NATO	GOVERNMENT	1:7"	CARBINE WITH FSB	CHROME MOLY VANADIUM
	07-077-06128	5.56 NATO	GOVERNMENT	1:7"	CARBINE WITH LPG	CHROME MOLY VANADIUM
11.5"	07-077-16522-018	5.56 NATO	GOVERNMENT	1:7"	CARBINE	CHROME MOLY VANADIUM
	07-077-07108	5.56 NATO	GOVERNMENT	1:7"	CARBINE WITH LPG	CHROME MOLY VANADIUM
12.5"	07-077-17022-018	5.56 NATO	GOVERNMENT	1:7"	CARBINE	CHROME MOLY VANADIUM
	07-077-10135	5.56 NATO	GOVERNMENT	1:7"	CARBINE WITH FSB	CHROME MOLY VANADIUM
	07-077-07208	5.56 NATO	GOVERNMENT	1:7"	CARBINE WITH LPG	CHROME MOLY VANADIUM
14.5"	07-075-18024-018	5.56 NATO	M4	1:7"	CARBINE	CHROME MOLY VANADIUM
	07-075-02153	5.56 NATO	M4	1:7"	CARBINE WITH FSB	CHROME MOLY VANADIUM
	07-075-07157	5.56 NATO	M4	1:7"	CARBINE WITH LPG	CHROME MOLY VANADIUM
	07-077-19125-018	5.56 NATO	GOVERNMENT	1:7"	MID	CHROME MOLY VANADIUM
	07-077-07308	5.56 NATO	GOVERNMENT	1:7"	MID WITH LPG	CHROME MOLY VANADIUM
	07-078-08072-018	5.56 NATO	LIGHTWEIGHT	1:7"	MID	CHROME MOLY VANADIUM
16"	07-075-08174-018	5.56 NATO	M4	1:7"	CARBINE	CHROME MOLY VANADIUM
	07-075-10114	5.56 NATO	M4	1:7"	CARBINE WITH FSB	CHROME MOLY VANADIUM
	07-075-21074	5.56 NATO	M4	1:7"	CARBINE WITH LPG	CHROME MOLY VANADIUM
	07-077-09173-018	5.56 NATO	GOVERNMENT	1:7"	MID	CHROME MOLY VANADIUM
	07-077-02114	5.56 NATO	GOVERNMENT	1:7"	MID WITH FSB	CHROME MOLY VANADIUM
	07-077-06158	5.56 NATO	GOVERNMENT	1:7"	MID WITH LPG	CHROME MOLY VANADIUM
	07-078-09136-018	5.56 NATO	LIGHTWEIGHT	1:7"	MID	CHROME MOLY VANADIUM
	07-078-06106	5.56 NATO	LIGHTWEIGHT	1:7"	MID WITH LPG	CHROME MOLY VANADIUM
	36-116-06041-018	300BLK	S2W	1:8"	CARBINE	CHROME MOLY VANADIUM
	29-116-07141-018	6.8 SPCII	S2W	1:11"	MID	CHROME MOLY VANADIUM
18"	07-116-05191-018	5.56 NATO	S2W	1:7"	MID	CHROME MOLY VANADIUM
	29-116-07241-018	6.8 SPCII	S2W	1:11"	MID	CHROME MOLY VANADIUM
	07-116-05042-018	5.56 NATO	S2W	1:7"	RIFLE	CHROME MOLY VANADIUM
	07-088-09178-053	5.56 NATO	MK12	1:7"	RIFLE	STAINLESS STEEL



CATEGORY	AR PARTS & GEAR	MFR #
UPPER PARTS	BIG HOLE UPPER (W/FEED RAMPS)	04-012-09001
	.315 BIG HOLE PIVOT PIN	15-028-09004
	MK12 GAS BLOCK, .750	25-081-00029
	.750 LOW PROFILE GAS BLOCK	25-079-05006
	BOLT UP SYSTEM BARREL NUT	01-002-07234-131
	AR-15 BARREL NUT	01-013-22032
	GRIP-N-RIP AR-10 CHARGING HANDLE	04-013-04129-006
	GRIP-N-RIP AR-15 CHARGING HANDLE	04-013-03252-006
	CHARGING HANDLE ASSEMBLY	04-013-16532
	DDM4/ SLIM/ LITE RAIL III HARDWARE PACK	01-134-01053
	6.8MM SPC BOLT CARRIER GROUP, COMPLETE, F/A, HP & MPI TESTED	04-013-08082
	5.56MM BOLT CARRIER GROUP, COMPLETE, F/A, HP & MPI TESTED	04-013-19032
	6.8MM SPC BOLT ASSEMBLY	04-013-20032
	5.56MM BOLT ASSEMBLY	04-013-22182
LOWER PARTS	LOWER PARTS KITS (SEMI AUTO)	05-013-21007
	RECEIVER EXTENSION (6) POSITION	05-013-16186
	CAR H-BUFFER ASSEMBLY	05-013-17032
	CAR BUFFER SPRING	15-024-16146
	CASTLE NUT	15-057-20039
GEAR	DANIEL DEFENSE SOFT RIFLE CASE	11-066-15043

CATEGORY	ACCESSORIES & GEAR	MFR #
TOOLS	BOLT UP SYSTEM BARREL NUT WRENCH	16-002-08234-140
	OMEGA X/MODULAR FLOAT RAIL BARREL NUT WRENCH	16-033-08184-140
	ARMORERS BOLT UP SYSTEM BARREL NUT WRENCH	16-002-15009-105
MUZZLE DEVICES	FLASH SUPPRESSOR	06-048-08061
	FLASH SUPPRESSOR EXT	06-048-08123
	FLASH SUPPRESSOR 30 CAL	06-048-05163
	SUPERIOR SUPPRESSION DEVICE	06-048-04074
	SUPERIOR SUPPRESSION DEVICE EXT	06-048-04165
	SUPERIOR SUPPRESSION DEVICE 30 CAL	06-048-06111
	MUZZLE CLIMB MITIGATOR	06-049-16140
MAGAZINE	DD MAGAZINE, 5.56, 32 ROUNDS	13-072-16539-006
	DD MAGAZINE, 5.56 (12 PACK), 32 ROUNDS	13-072-00160-006
	DD WAVE MUZZLE BRAKE	06-049-11048
SLING MOUNTS	DD WAVE MUZZLE BRAKE 30 CAL	06-049-10697
	M-LOK QD ATTACHMENT POINT	03-018-14235
	RAIL MOUNT QD SWIVEL ATTACHMENT POINT W/SWIVEL	03-021-30029
	REAR RECEIVER END PLATE W/QD SWIVEL	03-018-30026
	EZ CAR QD W/SWIVEL	03-019-05026
	HEAVY DUTY QUICK DETACH SLING SWIVEL	13-018-16037
SIGHTS	REAR RECEIVER CARBINE QD SWIVEL	03-018-04062
	A1.5 FIXED REAR SIGHT	19-064-11002
	RAIL MOUNTED FIXED FRONT SIGHT	19-017-04013
	FIXED FRONT/REAR SIGHT COMBO	19-088-09116
	FIXED FRONT/REAR SIGHT COMBO - TORNADO	19-088-09116-012
PICATINNY ACCESSORIES	FIXED FRONT/REAR SIGHT COMBO - MIL SPEC +	19-088-09116-011
	MICRO MOUNT (W/LOWER 1/3 ADAPTER)	03-045-18025
	1 O'CLOCK OFFSET MOUNT	03-029-13017
	BI-POD MOUNT ADAPTER	03-141-10324
M-LOK ACCESSORIES	RAIL PANEL SET	21-010-02927-006
	M-LOK QD ATTACHMENT POINT	03-018-14235
	QD SLING MOUNT W/ SWIVEL	03-021-15136
	SCOUT LIGHT MOUNT	03-020-02093
	BIPOD ADAPTER	03-141-81675
	PICATINNY RAIL SECTION	03-088-02253
	M-LOK HAND STOP	21-088-22086



Building the best isn't something we try to do. Trying is for those who have the option to fail. We build the best because it's part of our DNA. We're genetically coded to make sure that every firearm and accessory stamped with the Daniel name is the absolute best it can be before it ever winds up in your hands. And once there, you'll feel the quality and workmanship—the Daniel DNA—all the way down to a molecular level.



BORN IN THE U.S.A.

Every Daniel firearm, part, or accessory is designed and manufactured right here in the U.S., in Black Creek, Georgia. American employees working American jobs to ensure that all of our products exude American quality. We're committed to providing excellence to our civilian customers looking for best-in-class items for home defense and recreational and competitive shooting. But we also support the military and law enforcement communities that protect our freedoms with top-tier firearms and accessories designed to get the job done and them home safely. Our support for Second Amendment rights is unwavering because without the teeth of the Second Amendment, there is no First Amendment...and no America as we know it.



FORWARD-THINKING DESIGN & SUPERIOR MATERIALS

If you're not pushing forward, you're standing still. Our product engineering continually extends boundaries and renders the status quo obsolete. But we don't design for design's sake. We take a customer-centric approach, always asking the question, "What are the features of this design that benefit the ones who will actually be using this product?" And even the best design in the world is useless if you bring it to fruition using inferior materials. So we build our forward-thinking-designed products out of only the finest materials. Things like ultra-high-strength stainless steel, aircraft-grade aluminum and carbon-fiber-reinforced polymers.



PERFORMANCE-DRIVEN RELIABILITY

All of Daniel's products are designed and built first and foremost to perform and help you get the job done. Every time. So we take reliability and durability very seriously and test our products to try to purposely make them fail. They seldom do, but if one does, it's scrapped and doesn't make it out of our facilities. If we notice a pattern, it's back to the drawing board. And, since everyone's idea of performance isn't the same, and needs change over time, we manufacture our firearms with built-in upgrades and make them fully customizable. So no matter what you're looking to do, chances are we have the SKU for you.



PRECISION, STATE-OF-THE-ART MANUFACTURING

Most firearm "manufacturers" are content to simply assemble the parts made by other actual manufacturers—many located overseas. Not Daniel. We use state-of-the-art technology and robotics to manufacture our own parts. All of our barrels are made from proprietary steel and stainless steel alloys on GFM Radial Cold Hammer Forging machines. Over 90 CNC machines precision mill parts and components with exacting tolerances. And once something is manufactured, we exercise industry-leading quality-control measures and technology—like utilizing coordinating measuring machines, optical vision systems, and in-house-designed specialty gauging to make sure every component meets or exceeds our demanding standards. Then, and only then, do our products make it into your hands. Because if we won't sign off on it, you don't sign for it.

ISO 9001:2015 Certified: After undergoing a rigorous qualification process that examined every department of the company, Daniel Defense was issued ISO 9001:2015 certification for quality management systems in 2020. This globally recognized certification demonstrates our dedication to achieving the highest levels of quality and ensuring that all of our products meet or exceed regulatory requirements—and customer expectations.



GUARANTEED LIFETIME PERFORMANCE

Daniel products are guaranteed for a lifetime. Not your lifetime—as a lot of manufacturers try to get by with—but the lifetime of the product. Because we design and manufacture our products to last and be appreciated and passed down through the generations. Which means it doesn't matter whether you're the first or fifth owner; we stand behind our product. And if you ever do have a problem, our Customer Service Team—American Daniel employees located in America—will be happy to assist you and make things right. Because we know our job doesn't end once a sale is made. As long as you're behind one of our products, so are we.



JOIN TEAM DANIEL

Got a Daniel?™ We'd love to see it in action!

#danieldefense



Share your photos and videos on social media, and don't forget to tag us at:
[@DanielDefense](https://twitter.com/DanielDefense)

CONTACT

CORPORATE OFFICE:
101 Warfighter Way
Black Creek, GA 31308
1-866-554-GUNS
DanielDefense.com

**MILE TEAM /
MILITARY ORDERS:**
DDMILE@DanielDefense.com

ARMORERS TRAINING:
912-851-3251
DDMILE@DanielDefense.com

**SIGN UP AND RECEIVE 10%
OFF YOUR FIRST ORDER.**

Show your passion for Daniel Defense with branded tees, hats, accessories and more. Featuring gear perfect for everyday wear.

USE CODE: **CATALOG2023**

DEALER LOCATOR

TO FIND A DEALER NEAR YOU VISIT:
[DANIELDEFENSE.COM/DEALERS](https://danieldefense.com/dealers)

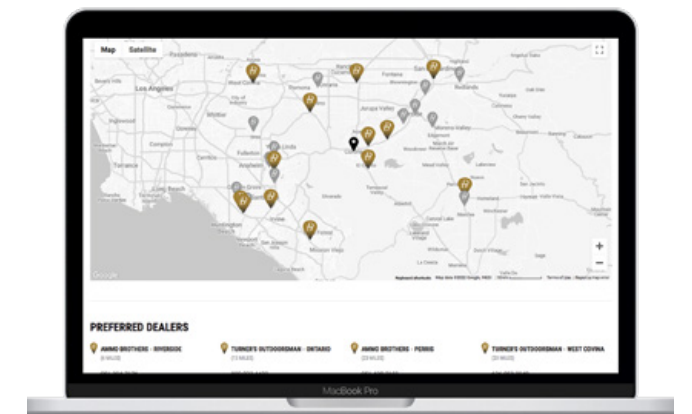



SEE FULL PRODUCT LINE:
DANIELDEFENSE.COM

DD®